



ORTHOPEDIC CATALOGUE



Orthopedic Instruments
.Gynecology Instruments
.Dental Instruments
.Surgical Instruments



Info@htsurgico.com



www.htsurgico.com



0092-320-5831682

ORTHOPEDIC DRESSING INSTRUMENTS

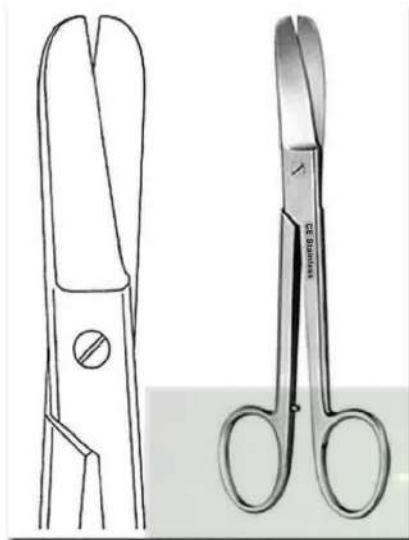

22-100-23
Lorenz Bandage Scissors
Heavy Pattern (23 cm / 9")



Also available
in 18.5 cm / 7 1/4"
& 20 cm / 8"

22-101-14
Lister Bandage Scissors
14.5 cm / 5 3/4"

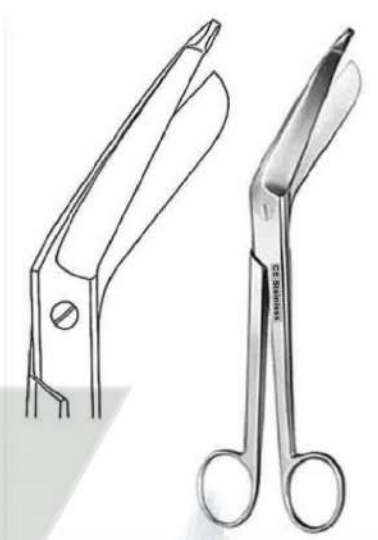

22-102-23
Bergmann Plaster Shears
Heavy Pattern
23.5 cm / 9 1/4"



22-103-20
Esmarch Plaster Shears
Heavy Pattern, Short Blades
20 cm / 8"



Also available
in 18 cm / 7 1/2"

22-104-16
Bandage Scissors
16 cm / 6 1/4"
Black Plastic Rings

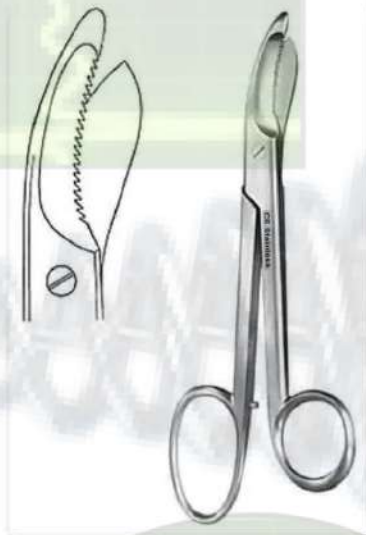

22-105-24
Bruns Plaster Scissors
24 cm / 9 1/2"
One Serrated Cutting Edge



B: 26 cm / 10"
C: 38 cm / 15"

22-106-00
Stille-Martin
Plaster Shears
A: 23 cm / 9"



22-107-15
Engel Plaster Saw 15.5 cm / 6"



22-108-20
Hopkins Plaster Knife
20 cm / 8"
with Wooden Handle



22-109-18
Esmarch
Plaster Knife
18 cm / 7"



22-110-18
Reiner
Plaster Knife



22-111-21
Martin
Plaster Knife



45-112-15
Engel Plaster Saw 15.5 cm / 6"

45-113-18
Bergmann
Plaster Saw
18 cm / 7"



PLASTER CAST INSTRUMENTS

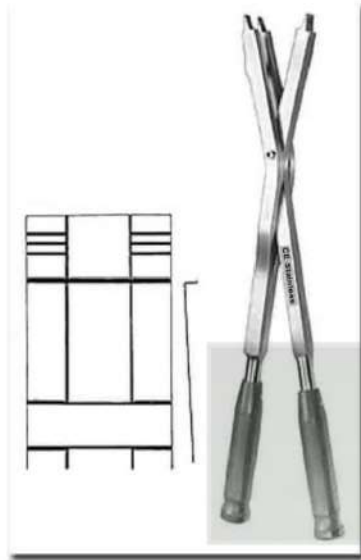

22-114-48
Hermann Plaster Spreader
48 cm / 19" Heavy Pattern



22-115-28
Hennig Plaster Spreader
28 cm / 11"



22-116-30
Hennig
Plaster Spreader
30 cm / 12"



22-117-30
Beeson Plaster Spreader
1.5 In Blade
30 cm / 12"



22-118-23
Walton Plaster Spreader
w/Spring 3 Prongs
23 cm / 9"

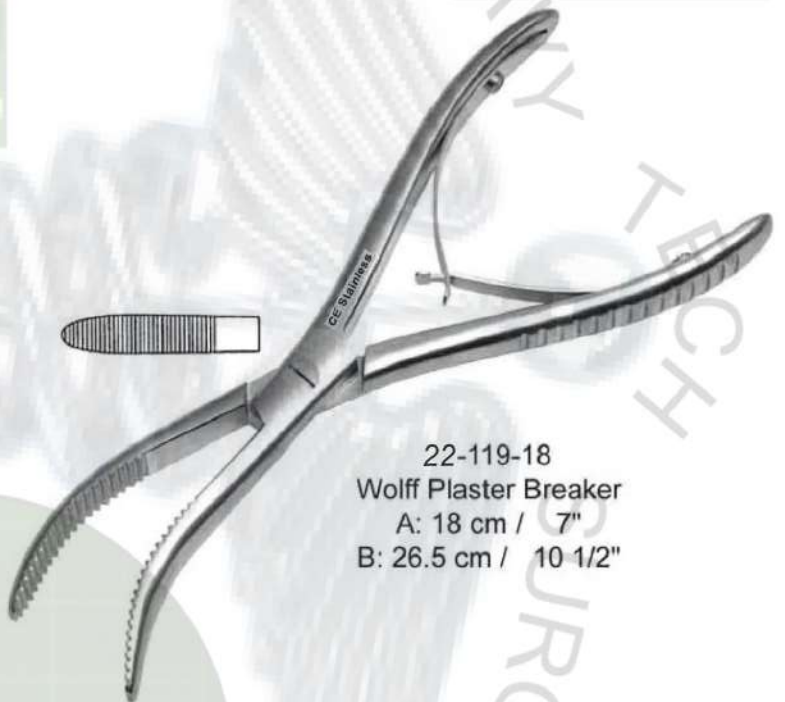

22-119-18
Wolff Plaster Breaker
A: 18 cm / 7"
B: 26.5 cm / 10 1/2"

TC Tipped

TC
GOLD

TC Tipped

TC
GOLD

Also Available
in Non TC
Version



22-120-18-TC
Lister
Bandage Scissors
TC / Handle gold
18 cm / 7"



22-121-24-TC
Bruns
Plaster Scissors
24 cm / 9 1/2"
Also Available
in Non TC
Version



AMPUTATION SAWS - GIGLI SAW

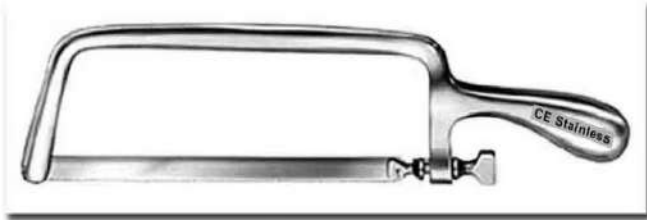

22-122-00 Charrière Amputation Saw
35 cm / 13 3/4"

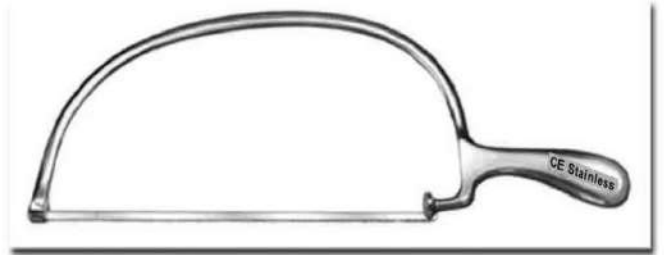

22-123-00 BIER Amputation Saw
40.5 cm / 16"



Spare Saw Blades

21.5 cm / 8 3/4" 12mm wide

21.5 cm / 8 3/4" 15mm wide

21.5 cm / 8 3/4" 18mm wide

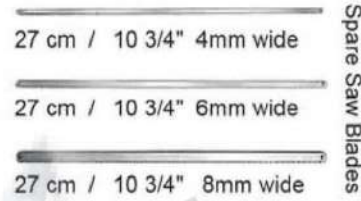

Spare Saw Blades

27 cm / 10 3/4" 4mm wide

27 cm / 10 3/4" 6mm wide

27 cm / 10 3/4" 8mm wide



22-124-24 Langenbeck Amputation Saw
24.5 cm / 9 3/4"



22-125-29 Satterlee Amputation Saw 29 cm / 11 1/2"
Also: Spare Saw Blade Available in 20 cm / 8 1/4" Size



22-126-27 Charrière Amputation Saw 27 cm / 10 1/2"



22-127-23 Satterlee Amputation Saw 23 cm / 9"

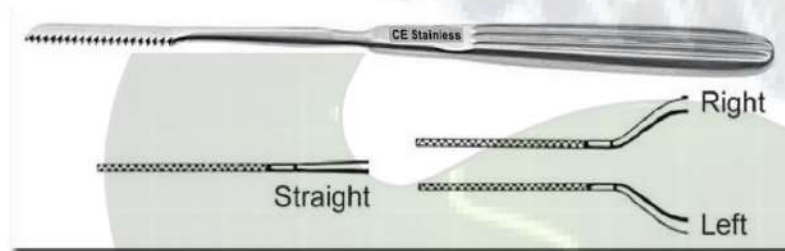

22-128-18 Joseph Amputation Saw 18 cm / 7"



22-129-30 Percy Amputation Shield 30 cm / 12"

- 22-130-00
- A: Gigli Saw 30cm
- B: Gigli Saw 50cm
- C: Tyler Gigli Saw (Large Cut) 30cm
- D: Tyler Gigli Saw (Large Cut) 30cm

enlarged detail



Gigli Saw Handles
SOLID

22-131-00 Gigli
Sold in Pair

22-132-01 Struly Gigli
Sold in Pair



Gigli Saw Handles
LOOP

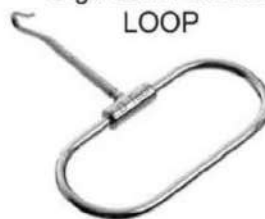

22-133-02
Gigli
Sold in Pair



22-134-03
Struly Gigli
Sold in Pair



22-135-30
BAILEY Gigli Saw Guide 30cm



22-136-28
POPPEL Gigli Saw Guide 28cm

REAMERS - AWLS - BONE HOOKS



22-137-13
Reamer
13.5 cm / 5 1/4"



22-138-18
Perthes Reamer
18 cm / 7"



22-139-21
Perthes Reamer
21.5 cm / 8 1/2"



22-140-14
Reamer
One concave side
14 cm / 5 1/2"



22-141-14
Glenoid Punch
20cm / 8"

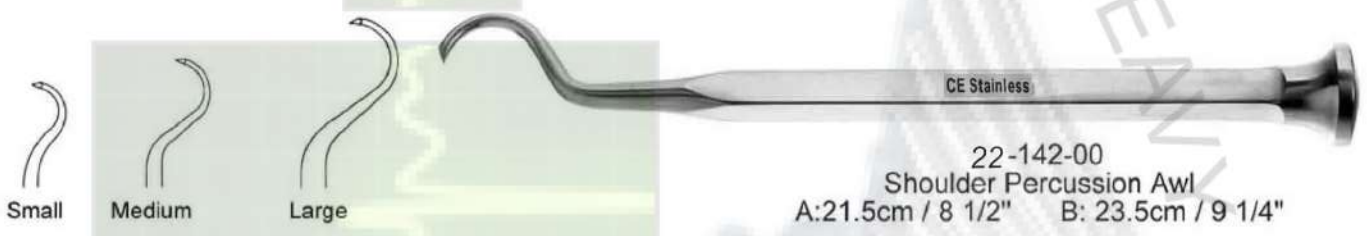

22-142-00
Shoulder Percussion Awl
A: 21.5cm / 8 1/2" B: 23.5cm / 9 1/4"



22-145-00
Shoulder Penetrating Awl
Fibre Handle
A: 18cm / 7" B: 23cm / 9"



22-143-28
Kuntscher Diamond Awl 28cm / 11"



22-144-00
Rush Awl / Reamer



22-146-23
Bone Hook
23cm / 9"

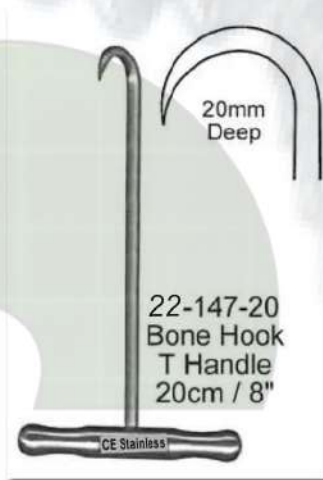

22-147-20
Bone Hook
T Handle
20cm / 8"



22-148-14
Bone Hook T Fibre Handle
14cm / 5 5/8"



22-149-00 Volkman Bone Hook

A: 20cm / 8" 19X27mm Sharn

B: 23cm / 9" 15X20mm Blunt

C: 23cm / 9" 15X20mm Sharn

C: 25cm / 9 3/4" 15X20mm Sharn



22-150-25
Pointed Awl
Fibre Handle
25cm / 10"

HAND BONE DRILLS

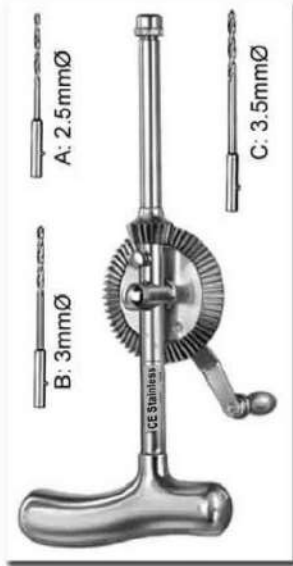

22-151-24
Stille-Sherman Hand Drill
24 cm / 9 1/2"
with 3 twist drills



22-152-20
Stille Hand Drill
20.5 cm / 8"
w/ 9 Twist Drills

Complete with Hand Drill art # 11-138-01

- Fig.A: 2.5 mmØ Twist Drill
- Fig.B: 3 mmØ Twist Drill
- Fig.C: 3.5 mmØ Twist Drill
- Fig.D: 4 mmØ Twist Drill
- Fig.E: 10 mmØ Trephine
- Fig.F: 5 mmØ Spherical Burr
- Fig.G: 8 mmØ Spherical Burr
- Fig.H: 12 mmØ Spherical Burr
- Fig.I: 16 mmØ Spherical Burr
- Fig.J: 1 mmØ Twist Drill
- Fig.K: 1.5 mmØ Twist Drill
- Fig.L: 2 mmØ Twist Drill

22-153-00

Conical Burr Fig.1: 9 mmØ

Conical Burr Fig.2: 14 mmØ

Spherical Burr Fig.3: 16 mmØ

Spherical Burr Fig.4: 22 mmØ

Extension Piece Fig.9

Flat Trephine Fig.5: 14 mmØ

Twist Drill Fig.6

Burr Fig.7

Burr Fig.7

22-154-00
Hudson Hand Drill
28 cm / 11"
complete with burs Fig. #. 1 - 4
and extension piece # 9.
(art # 11-145-01 for more acc)

22-155-00
HUDSON (Drills)
Sold Separately

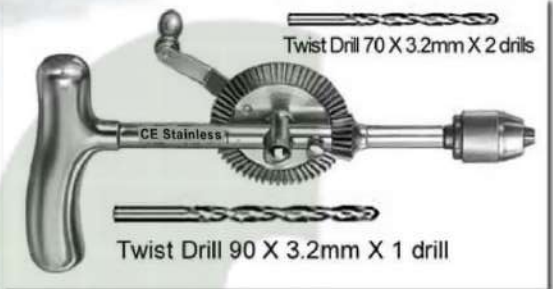

22-156-00 Moore Hand Drill
complete with a set of 3 twist drills

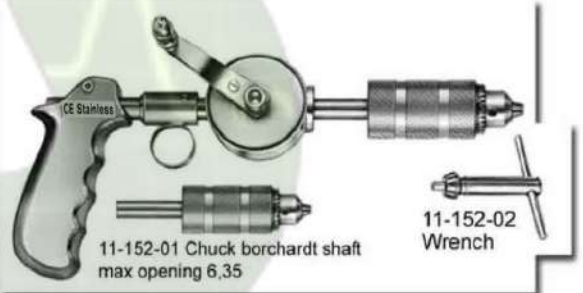

22-157-00
Martin Hand Drill with Chuck & Wrench



22-158-16
Bunnell Hand Drill
16cm,

Longitudinally Bored with 3-Jaw-Chuck
Light Metal Housing
opening up to 4mmØ



22-159-16
Bunnell Type
Hand Drill 16cm,

Twin Shade Powder Coated
Longitudinally bored with 3-Jaw-Chuck
light metal housing opening up to 4mmØ



22-160-00
Ralk Hand Drill

Light Metal Housing
Literally Angled Handle with 3-Jaw-Chuck
and key, opening up to 6,35mmØ

HAND BONE DRILLS - KEYS

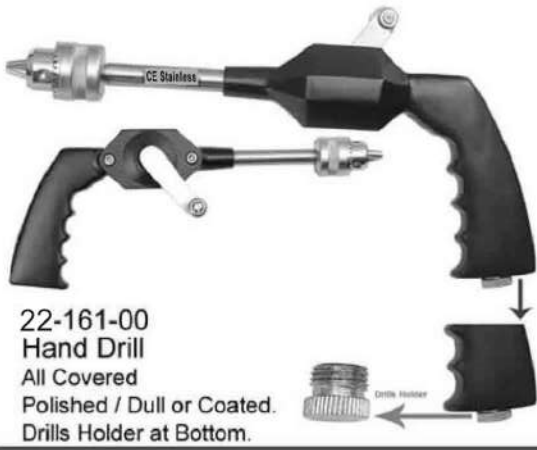

22-161-00
Hand Drill
All Covered
Polished / Dull or Coated.
Drills Holder at Bottom.



22-162-00
Hand Drill
All Covered
Light Weight
Polished / Dull or Coated.
Key Holder and Self Retaining Locking Mechanism



22-163-01
Box for Hand Drills W/ Art #s: 11-450-00
and 11-455-00 Outside Artificial Leather
/ Inside Jumbo Foam



22-164-00
Hand Drill
Polished / Dull or Coated.
Operated Horizontally and
Vertically



Comes with Keys



22-165-00
Hand Drill
Polished / Dull or Coated.
All Covered



22-166-00
Hand Drill
Polished / Dull
or Coated.
Open Housing



22-167-01
Hand Drill
Polished / Dull
or Coated.
Open Housing



22-168-00
Hand Drill
Polished / Dull
or Coated.
Semi Closed Housing



22-169-14 Vickers Easidriver 14 cm / 5 1/2"



-170-14 14cm / 5 1/2"
Handle W/ Chuck Longitudinally
Bored Accomodating up to 3,95mm



22-172-00
Handle with chuck
T-Shaped

22-173-01
Key



22-171-01
Key



22-174-01
Fibre T-Handle Key

DRILL BITS - BURRS ETC



22-175-00 5mm Borchardt Shaft Twist Drill
Long Working End

A: 2.0mm B: 2.5mm C: 3.0mm D: 3.2mm E: 3.5mm F: 4.0mm G: 5.0mm H: 6.0mm I: 7.0mm



22-176-00 5mm Borchardt Shaft Twist Drill

A: 1.0mm B: 1.5mm C: 1.8mm D: 2.0mm E: 2.2mm F: 2.5mm G: 2.8mm H: 3.0mm I: 3.2mm J: 3.5mm K: 4.0mm L: 5.0mm



22-177-00 5mm Borchardt Shaft Flat Trepine

A: 1.8mm B: 2.0mm C: 2.2mm D: 2.5mm E: 3.0mm F: 3.5mm G: 4.0mm H: 5.0mm



22-178-00 5mm Borchardt Shaft Spherical Burr
A: 3.0mm B: 4.0mm



22-179-00 5mm Borchardt Shaft Spherical Burr
A: 3.0mm B: 5.0mm

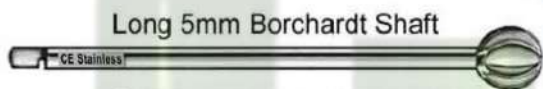

Long 5mm Borchardt Shaft

22-180-00 Doyen Spherical Burr

A:4mm B:6mm C:8mm D:10mm E:12mm F:14mm G:16mm

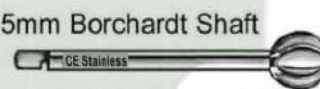

Short 5mm Borchardt Shaft

22-181-00 Doyen Spherical Burr

A:4mm B:6mm C:8mm D:10mm E:12mm F:14mm G:16mm

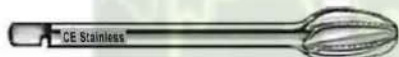

22-182-03 Doyen Conical Burr
Coarse Spacing 12mm Dia

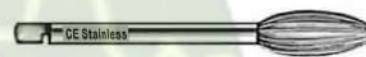

22-183-00 Doyen Conical Burr
Fine Spacing A:8mm / B:10mm



22-184-00 Doyen Cylindrical Burr
Coarse Spacing A:12mm / B:15mm



22-185-00 Albee Burr Oval
Coarse Spacing A:8mm / B:10mm / C:12mm



22-186-03 Albee Burr Pointed
7mm



22-187-03 Borchardt Burr Oval
Coarse Spacing 13mm



22-188-03 Flat Burr
Short Borchardt Shaft 25mm



22-189-03 Toti Trepine
Short Borchardt Shaft 8mm

BONE HOLDING CLAMPS



22-190-00
Standard

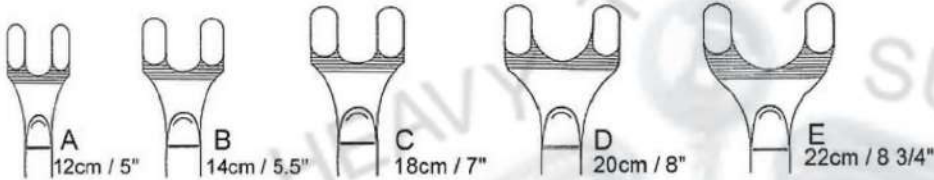

Gerster-Lowman Bone Holding Clamp



22-192-15
Gerster Traction Bar
15cm / 6"

22-191-00
Angled

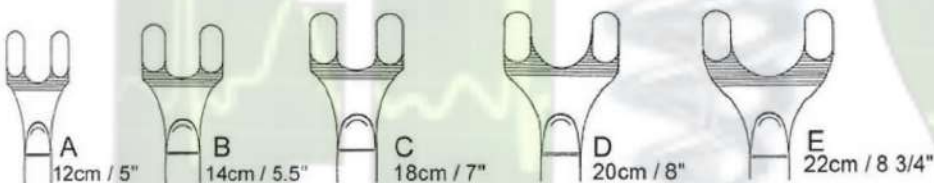

Gerster-Lowman Bone Holding Clamp

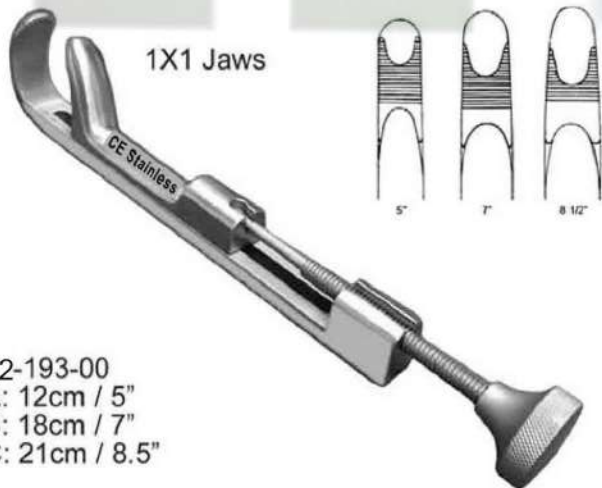

1X1 Jaws

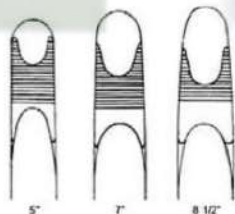

22-193-00
A: 12cm / 5"
B: 18cm / 7"
C: 21cm / 8.5"

Gerster-Lowman Bone Holding Clamp



2X2 Jaws

22-194-00
C: 18cm / 7"
B: 20cm / 8"

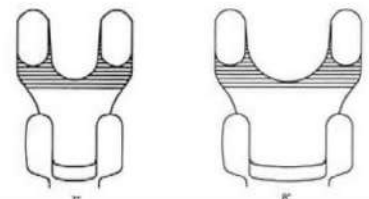

Gerster-Lowman Bone Holding Clamp

WISE GRIPS - PARALLEL GRIP PLIERS ETC



22-195-18 Flat Nose Plier
18.5 cm / 7 1/4" Parallel Grip SS



22-197-18 Flat Nose Plier / Cutter
18.5 cm / 7 1/4" Parallel Grip



22-200-22 Long Nose Plier / 22 cm / 8 1/4"



22-201-20
Vise Grip 20.5 cm / 8"
Stainless Steel



SLAP HAMMER w/ Threaded Shaft Head
to be used with 20-131-20 and 30-204-20



SLAP HAMMER w/ Hexa Shaft Head
to be used with 20-131-20 and 30-206-20



22-207-00 Regular Jaw Locking Plier
A: 18 cm / 7" B: 20 cm / 8"



22-196-23
Vise Grip 23 cm / 9"
Locking Plier



22-198-20
Vise Grip 20.5 cm / 8"
Locking Plier



22-199-18
Vise Grip 18 cm / 7"
Locking Plier



22-202-30
Needle Nose Locking Plier
30 cm / 12"



22-203-25
Needle Nose Locking Plier
25.5 cm / 10"



22-205-22
Needle Nose
Locking Plier
22 cm / 8.5"



22-208-00
Needle Nose Locking Plier
A: 22 cm / 8.5"
B: 25.5 cm / 10"
C: 30 cm / 12"

BENDING - WIRE CUTTING PLIERS



22-209-15
Combi-Flat Nose Pliers 15 cm / 6"
for Bending & Cutting



30-210-18
Flat Nose Pliers
18 cm / 7"
Parallel Grip



22-211-13 Flat Nose Pliers
13.5 cm / 5 1/4"



22-212-18 Round / Flat Nose Pliers
18 cm / 7"



22-213-16 Hackstock Flat
Nose Pliers 16cm / 6 1/4"
with longitudinal groove



22-214-17 Flat Nose Pliers
17 cm / 6 3/4" with crosswise groove



22-215-17
Flat Nose Pliers 17.5 cm / 7"



22-216-19
Flat Nose Pliers Pointed 19.5 cm / 7 3/4"



22-217-15
Platypus Nail
Pulling Forceps
15.5 cm / 6 1/4"

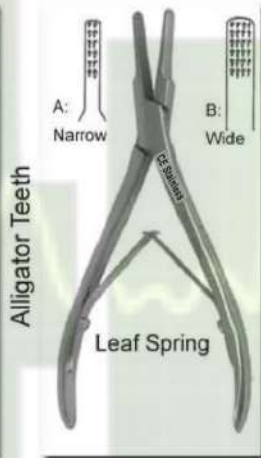

22-218-15
Platypus Nail
Pulling Forceps
15.5 cm / 6 1/4"



22-219-15
Round Nose Pliers
15.5 cm / 6 1/4"



22-220-15
Needle Nose Pliers
15.5 cm / 6 1/4"

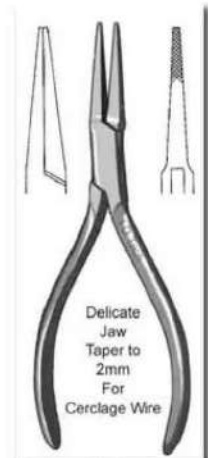

22-221-15
Flat Nose Pliers
15 cm / 6"

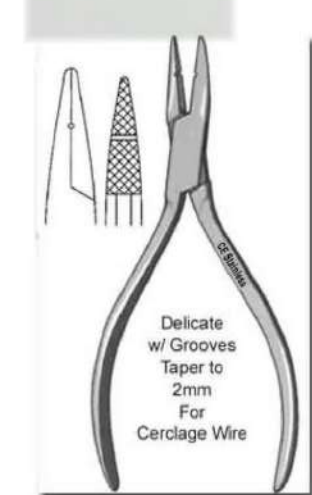

22-222-13
Needle Nose Pliers

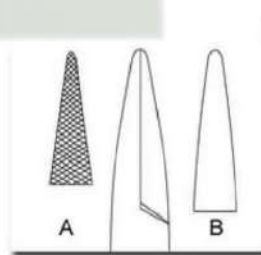

22-223-14
Needle Nose Pliers
Taper to 2mm Tip
14 cm / 5 1/2"
A: Fine Cross Serration
B: Smooth



22-224-18
18.5 cm / 7 1/4"
Wire Cutting Pliers



22-225-16
Hard wires up to 1.5mm Ø

BENDING - WIRE CUTTING PLIERS



22-226-14
14 cm / 5 1/2"

Circlage Pliers / Cutter

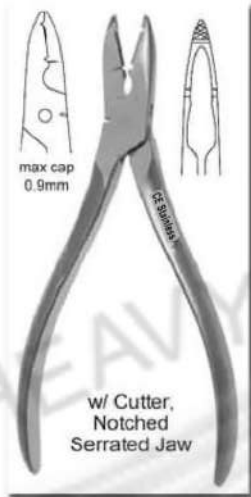

22-227-20
20 cm / 8"

Wire Bending Pliers

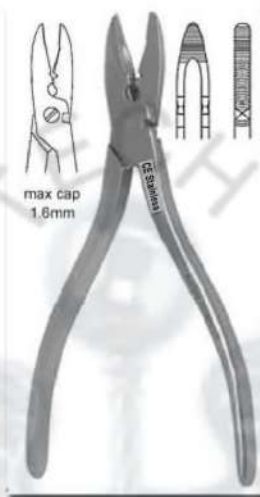

22-228-15
15 cm / 6"

Wire Bending Pliers



22-229-20
20 cm / 8"
Wire Bending Pliers
TUNGSTEN
CARBIDE



22-230-15
15 cm / 6"

Needle Nose Pliers

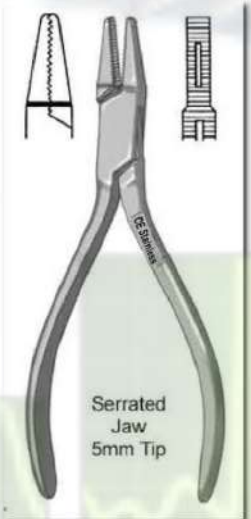

22-231-14
14 cm / 5 1/2"

Flat Nose Pliers

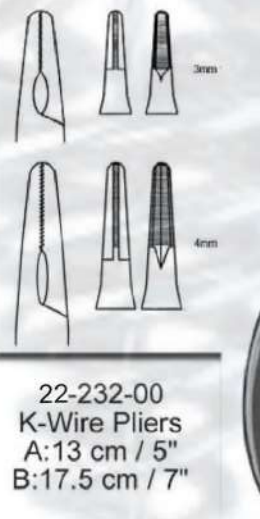

22-232-00
K-Wire Pliers
A: 13 cm / 5"
B: 17.5 cm / 7"



22-233-19
19 cm / 7 1/2"
Screw/Pin
Removing Pliers



22-234-14
14 cm / 5 1/2"
Pin Puller
Grips Small Pins



22-235-16
16 cm / 6 1/2"
Flat Nose Pliers
w/ Cutter
for Cerclage Wire



22-236-19
19 cm / 7 1/2"
Narrow
Nose Pliers
Heavy Jaws
for Pulling
Wire / Pins



22-237-17
17.5 cm / 7"
Long Jaw Pliers
2inch Long Jaw
Delicate

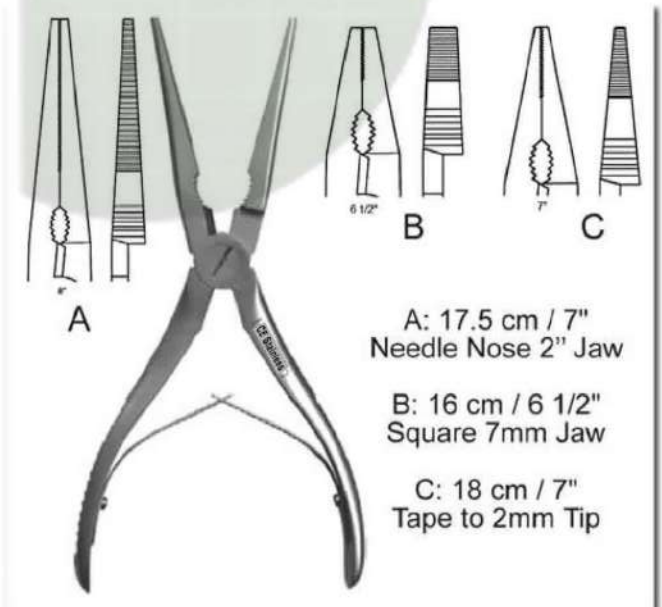

22-238-00
UNIVERSAL Pliers
Serrated w/ Heavyduty Spring and Cutting Edge
Max Cutting Cap: 1.1mm

A: 17.5 cm / 7"
Needle Nose 2" Jaw

B: 16 cm / 6 1/2"
Square 7mm Jaw

C: 18 cm / 7"
Tape to 2mm Tip

BENDING - PASSERS ETC



22-239-20
20 cm / 8"
Slip Joint Pliers



22-240-21
21 cm / 8 1/2"
Lineman Pliers

All TUNGSTEN CARBIDE

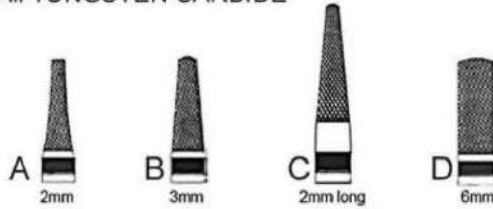

- A: 2mm Delicate Jaw TC
- B: 3mm Jaw TC
- C: 2mm Long Jaw TC
- D: 6mm Jaw TC

22-241-00
18 cm / 7"

Double Action Wire Extraction Plier

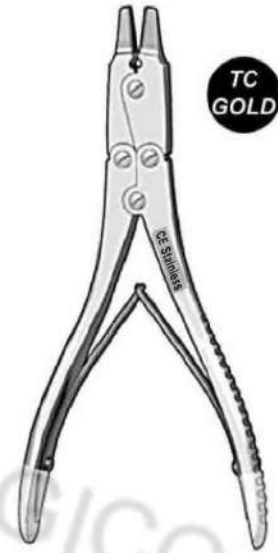

22-242-19 19 cm / 7 1/2" Gratloch Wire Bender

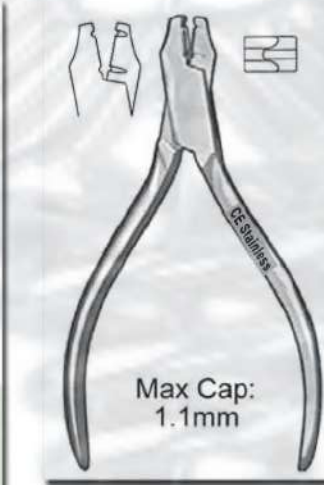

22-243-13
13.5 cm / 5"
K-Wire / Plate Bender



22-244-14
14.5 cm / 5 1/2"
K-Wire / Plate Bender

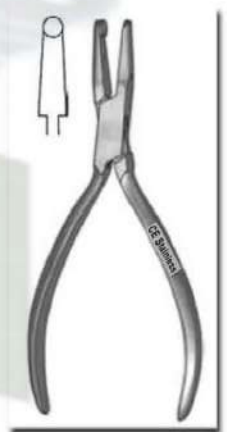

22-245-13
13.5 cm / 5"
Mini Plate
Bending Pliers

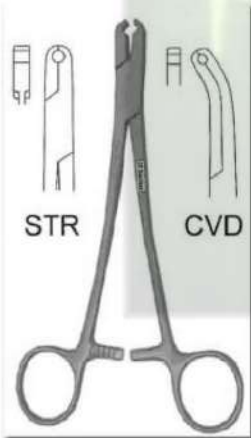

22-246-00
18 cm / 7 1/4"
Rod Holder
A: 4.0mm Rod
B: 4.76mm Rod
C: 6.35mm Rod
Straight or Curved

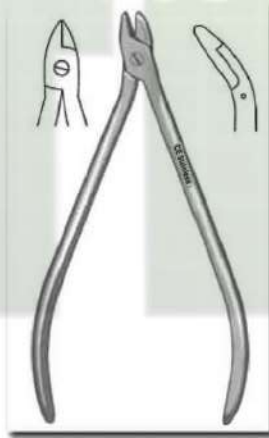

22-247-14
14.5 cm / 5 1/2"
Plate Bending Pliers



22-248-16
16 cm / 6 1/2"
Wire Pulling Forceps



22-249-16
16 cm / 6 1/4"
Wire Twister / Tightner

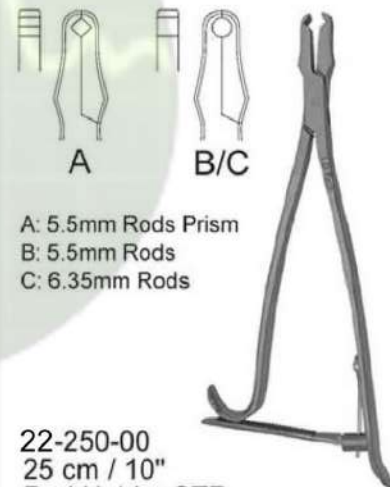

22-250-00
25 cm / 10"
Rod Holder STR
A: 5.5mm Rods Prism
B: 5.5mm Rods
C: 6.35mm Rods



22-251-21
21 cm / 8 1/2"
Rod Gripper
Adjustable

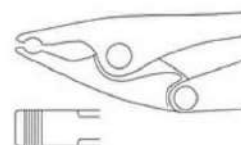

BONE WIRE MANAGEMENT



22-252-21
Loute Wire Tightener (21 cm / 8 1/4")



22-253-11
Wire Tightener
w/ T Handle
11 1/2 cm / 4 1/2"



22-254-21
Wire Tightener 12 cm / 4 3/4")

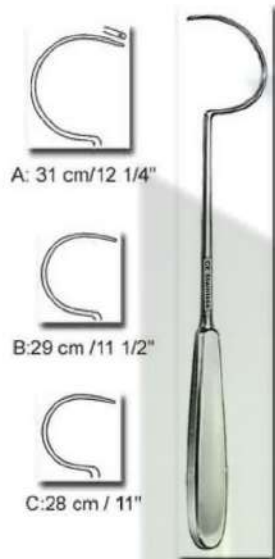

A: 31 cm / 12 1/4"
B: 29 cm / 11 1/2"
C: 28 cm / 11"

22-255-00
Demel Wire Guide



CVD
Crochet Hook
18cm / 7 1/4"

22-256-18
Bankert Ligature Carrier



CVD
Crochet Hook
Fiber Handle
A: 18cm / 7"
B: 23cm / 9"

22-257-00
Suture Passer



CVD
Suture Hole
Fiber Handle
A: 18cm / 7"
B: 23cm / 9"

22-258-00
Suture Passer

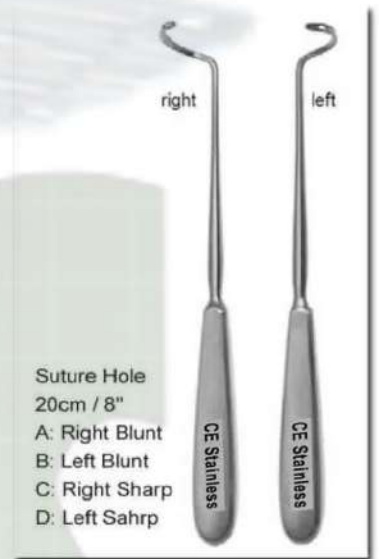

Suture Hole
20cm / 8"
A: Right Blunt
B: Left Blunt
C: Right Sharp
D: Left Sahrp

22-259-00
Deschamps Ligature Carrier

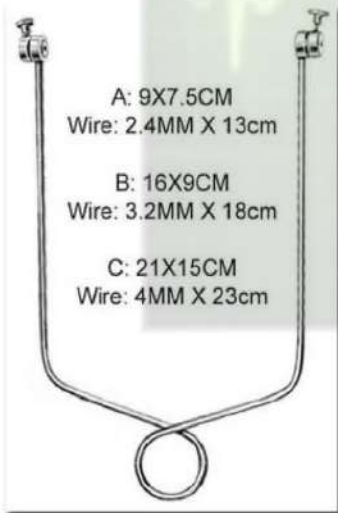

22-260-00
Böhler Extension
Bow for femur & knee

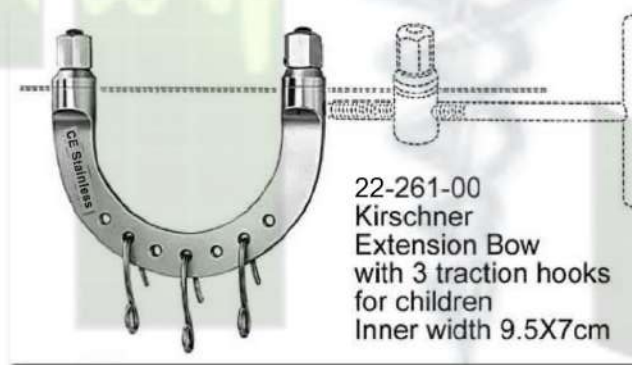

22-261-00
Kirschner
Extension Bow
with 3 traction hooks
for children
Inner width 9.5X7cm

22-143-02
for Wrist / Ankle
10.5X10.5cm

22-143-03
for Elbow
12X12cm

22-143-04
for Knee
15.5X15.5cm

22-143-05
for Femur
20X15.5cm



22-262-00 (Kirschner) Extension Bow
A: Small: 18.5 cm / 7 1/4"
B: Large: 26.5 cm / 10 1/2"
with 3 traction hooks



-263-18
Wire Strainer 18.5 cm / 7 1/4"

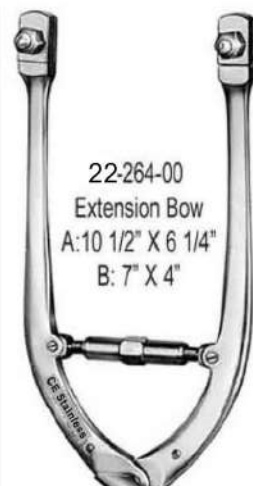

22-264-00
Extension Bow
A: 10 1/2" X 6 1/4"
B: 7" X 4"



22-265-00
Fixation Discs
for wire drills, pair

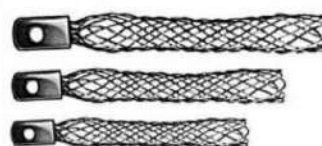

22-266-00 Extension Sleeve

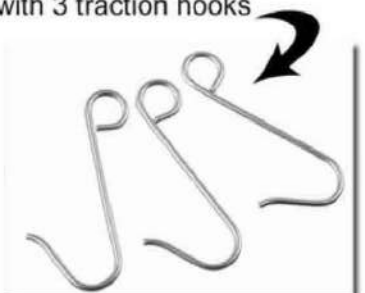

22-267-00 Traction Hook
for Extension Bows



22-268-20
Wrench 20cm / 8"

FINGER RING CUTTING - LEAD HANDS - BIOPSY TOOLS



22-269-00
Martin-Ideal
Finger Nail Drill



22-273-14
Radolf
Nail Extracting Forceps

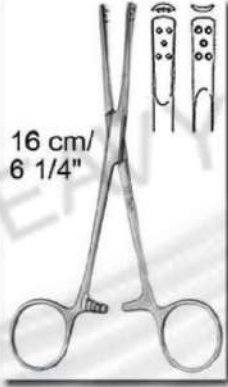

22-274-16
Nail Extracting
Forceps



22-270-10 Feldheim Tourniquet
10cm / 4"



22-275-18
Martin Finger
Ring Saw 18.5 cm / 6 3/4"
Spare Blades are Available
Separately



22-271-16
Walton
Finger Ring Saw
16 cm / 6 1/4"



22-272-17
Finger Ring Saw
17 cm / 6 3/4"



22-276-00
Finger Ring Saw Cutter Spare



22-277-00 Lead Hand for Kids / Adults



22-278-00 Lead Hand for Kids / Adults



22-279-00
Champy-OSU Bone Biopsy Instruments
Consisting of trocar, a toothed trephine
and a plunger for taking tibial and
iliac bone grafts through a closed technique



22-280-00
Champy Cancellous Bonegraft Mill
Outer Dia: 17mm
Inner Dia: 16mm



22-281-00
Champy Bone Biopsy Instruments
A: Outer Dia: 5mm Inner Dia: 4mm
B: Outer Dia: 8mm Inner Dia: 7mm

TAMPER - IMPACTORS - PACKERS

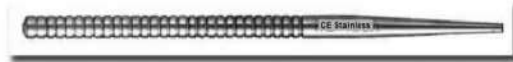

22-282-00 15.5cm/6" Bone Tamper Tip Sizes: 2-3-4-5-6-8-10mm



A: 2mm
B: 3mm
C: 4mm
D: 5mm

F: 6mm
G: 8mm
H: 9mm
I: 10mm

Knurling Handle

22-283-00 Bone Tamper



3mm 5mm 8mm

Cross-Serrated
A: 3mm
B: 5mm
C: 8mm

22-284-17 17cm / 6 1/2" Bone Impactor / Teflon Tip

22-285-00 20cm / 8" Caspar Bone Tamper

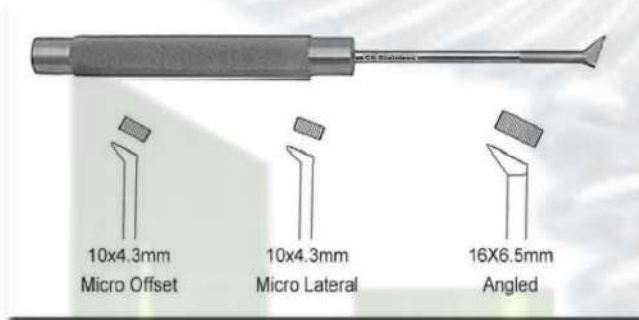

10x4.3mm
Micro Offset

10x4.3mm
Micro Lateral

16X6.5mm
Angled

22-286-00 21cm / 8 1/2" Lumbar / Cervical Impactor

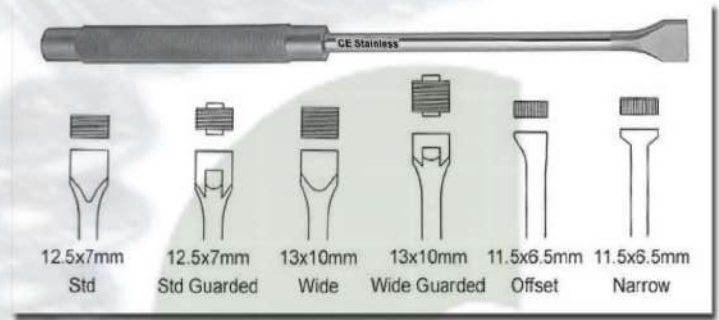

12.5x7mm
Std

12.5x7mm
Std Guarded

13x10mm
Wide

13x10mm
Wide Guarded

11.5x6.5mm
Offset

11.5x6.5mm
Narrow

22-287-00 21cm / 8 1/2" Lumbar / Cervical Impactor

22

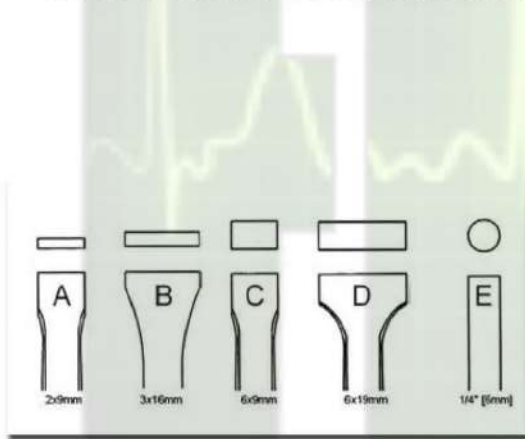

2x9mm

3x16mm

6x9mm

6x19mm

1/4" (6mm)

A: 2X9mm B: 3X16mm
C: 6X9mm D: 6X19mm
E: 6mm Dia

22-288-00 25cm / 10" Bone Chip Packer



9.5mm DIA

-289-43 43cm / 17" Bone Tamper



BONE FILES - RASPS



22-290-30 Putti Bone Rasp Round / Semi Round
30cm / 11 3/4"



22-292-28 Bone File 28 cm / 11" w/ Hollow Handle
Semi Round



22-294-22 Bone File 22 cm / 8 3/4"
Flat / Round



22-291-27 Putti Bone Rasp Curved / Straight
27cm / 10 3/4"



22-293-24 Bone File 24.5 cm / 9 3/4"
w/ Hollow Handle Semi Round



22-295-22 Bone Rasp 22 cm / 8 3/4"
Flat / Round



22-296-18 Bone File 18 cm / 7"
Fibre Handle / Cross-Hatch



22-297-18 Bone File 18 cm / 7"
Fibre Handle / Linear



22-298-18 Bone File 18 cm / 7"
Fibre Handle / Straight



22-299-18 Bone File 18 cm / 7"
Fibre Handle / CVD Forward



22-300-18 Bone File 18 cm / 7"
Fibre Handle / CVD Backward



22-301-18 Bone File 18 cm / 7"
Fibre Handle / STR Diamond Coated



22-302-18 Bone File 18 cm / 7"
Fibre Handle / CVD Diamond Coated

BONE FILES - RASPS



22-303-00 A / B / C / D / E
Miller-Colburn Bone File 18 cm / 7" Downwards Cut



22-304-00 A / B / C / D /
Miller-Colburn Bone File 18 cm / 7" Cross Cut



22-305-21
Bone Rasp
21 cm / 8.5"
13mm
Fine/Coarse
Straight

22-306-16
Bone Rasp
Joseph
16cm / 6.25"
8mm
Fine Cross Serr
Straight

22-307-19
Bone Rasp
Lewis
19cm / 7.5"
8mm
Straight

Fine Serr
Coarse Serr

22-308-20
Bone Rasp
Cottle
20cm / 8"
7mm
Plain Serr
Downward

22-309-18
Bone Rasp
Maltz
18cm / 7"
9mm
Plain
Coarse Serr
Downward

22-310-18
Bone Rasp
Aufricht
18cm / 7"
9mm
Coarse Serr
CVD



22-311-21
Bone Rasp
Fomon
21 cm / 8.5"
8mmX40mm
Coarse Serr
4 Sided
Flat / Convex Baldes



22-312-21
Bone Rasp
Fomon
21 cm / 8.5"
8mmX40mm
Fine Serr
4 Sided
Flat / Convex Blades



22-313-21
Bone Rasp
Kleinert Kurtz
21 cm / 8.5"
8mmX45mm
Fine/Coarse Serr
4 Sided
Flat / Convex Blades



22-314-21
Bone File / Rasp
21 cm / 8.5"
18mm
Fine / Coarse Serr

RETRACTORS - BONE LEVERS

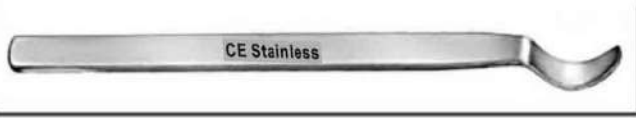

22-315-16 Bone Lever
16 cm / 6 1/4"

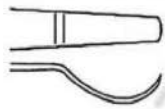

22-318-16 Hohman, Mini Bone Lever
16 cm / 6 1/4" 14 mm tip

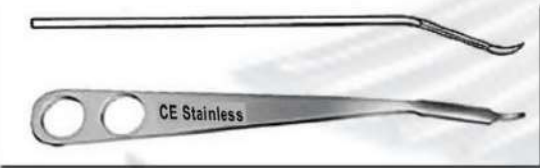

22-320-22 Hohmann Bone Lever
22 cm / 8 3/4" 8 mm Tip narrow tip

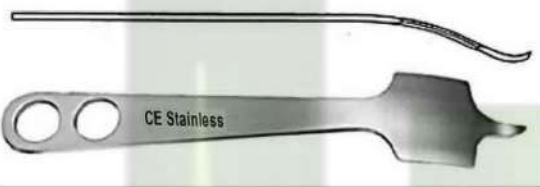

22-322-23 Hohmann Bone Lever
23.5 cm / 9 1/4" 43 mm Tip narrow tip



22-325-25 Lange-Hohmann Bone Lever
25 cm / 9 3/4" 22mm Tip wide tip with groove



22-327-00 Hohmann Bone Lever 27.5 cm / 10 3/4"
24mm Tip wide, round tip



Sizes Available
A: 75X30mm
B: 100X30mm

22-332-00 A / B Taylor Spinal Retractor
16 cm/6 1/4" pointed end



22-316-16 Hohman, Mini Bone Lever 16 cm / 6 1/4" 6mm tip



22-317-16 Hohman, Mini Bone Lever 16 cm / 6 1/4" 8 mm tip



22-319-12 Hohman, Mini Bone Lever 12 cm / 4 3/4" 14 mm tip



22-323-00 Hohmann Bone Lever
13cm/5" A:3mm B:5mm C:7mm



22-321-23 Hohmann Bone Lever
23.5 cm / 9 1/4" 18 mm Tip narrow tip



22-324-29 Hohmann Bone Lever 29 cm / 11 1/2"
35mm Tip wide tip

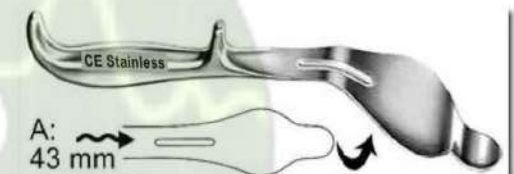

22-326-24 A / B Bennett Bone Lever
24 cm / 9 1/2"

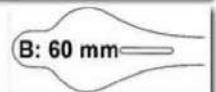

22-328-25 Hohmann Bone Lever 25 cm / 9 3/4" 70 mm Tip narrow tip



22-330-23 Hohmann Bone Lever
23.5 cm / 9 1/4" 43mm Tip narrow tip



22-333-25 Hohmann Bone Lever 25.5 cm / 10"
22mm Tip wide tip



22-329-26 Blount Knee Retractor
26.5 cm / 10 1/2" blunt



22-331-26 Blount Knee Retractor
26.5 cm / 10 1/2"



22-334-17 Blount Knee Retractor
17.5 cm / 7"

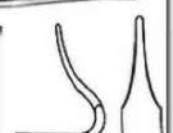

RETRACTORS - BONE LEVERS



A: 32X81mm
B: 38X81mm

22-335-19 Fukuda Retractor
19 cm / 7 1/2" T Handle



22-336-28 Browne - Deltoid Retractor
28 cm / 11" T Handle w/ Ring



22-337-18 Humeral Head Retractor
18 cm / 7" Strong Curved



22-338-18 Bristow / Bankart
Humeral Retractor
18 cm / 7"



22mm
Blade

1 Sharp
Prong

22-339-25
Capsule Retractor
25 cm / 10"



22mm
Blade

2 Sharp
Prong

22-340-25
Capsule Retractor
25 cm / 10"



22mm
Blade

3 Sharp
Prong

22-341-25
Capsule Retractor
25 cm / 10"

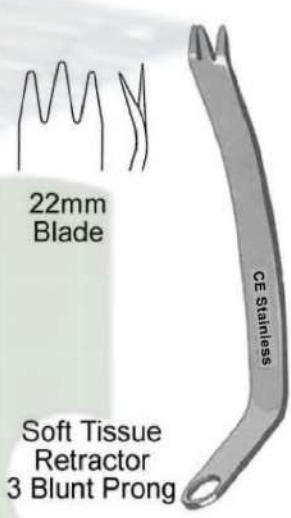

22mm
Blade

Soft Tissue
Retractor
3 Blunt Prong

22-342-19
Bristow/Bankart
19 cm / 7 1/2"



A: 13MM
B: 18mm
C: 20mm
D: 23mm

22-343-00
Blade Retractor
19 cm / 7 1/2"



13X18mm
Blade

T Handle

22-344-13
Smillie Retractor
13cm / 5"



13X55mm
Blade

T Handle

22-345-14
Smillie Retractor
14cm / 5 1/2"



Small: 19X32mm
Medium: 19X45mm
Large: 19X60mm
T Handle

22-346-00
Smillie Retractor
Angled Blade 14cm / 5 1/2"



Medium Blade:
57/69mm Deep
11mm Wide

Large Blade:
63/76mm Deep
11mm Wide

22-347-15
Z Knee Retractor
15 cm / 6"



9X38mm Blade

22-348-22
Knee Retractor

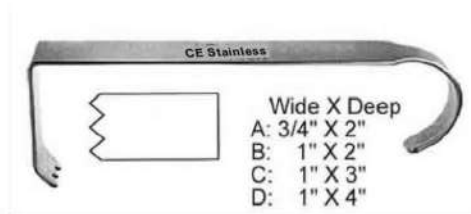

Wide X Deep
A: 3/4" X 2"
B: 1" X 2"
C: 1" X 3"
D: 1" X 4"

22-349-24
Hibbs Retractor
24 cm / 9 1/2" Sharp Teeth

RETRACTORS - BONE LEVERS

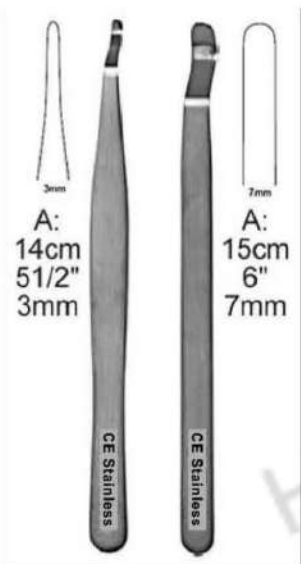

A:
14cm
5 1/2"
3mm

A:
15cm
6"
7mm

22-350-00
Hayes Retractor



Length:
A: 15cm / 6"
B: 15.5cm / 6 1/4"
C: 15cm / 6"
D: 15.5cm / 6 1/4"

22-351-00
Mini Hohmann Bone Levers
A: Blade: 6mm width/35mm drop
B: Blade: 6mm width/17mm drop
C: Blade: 8mm width/35mm drop
D: Blade: 8mm width/17mm drop

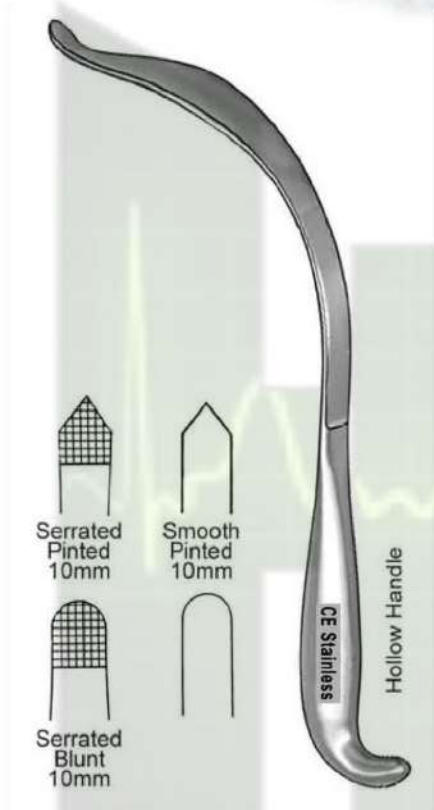

22-352-26
Aufranc Cobra Retractor
A: 26cm / 10 1/2"

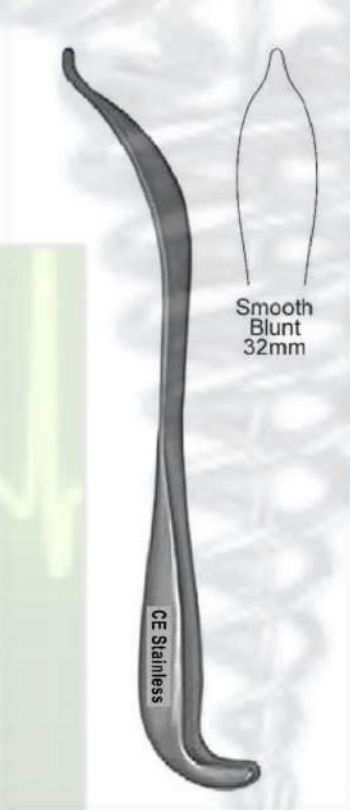

22-353-27
Aufranc Cobra Retractor
A: 27.5cm / 11"

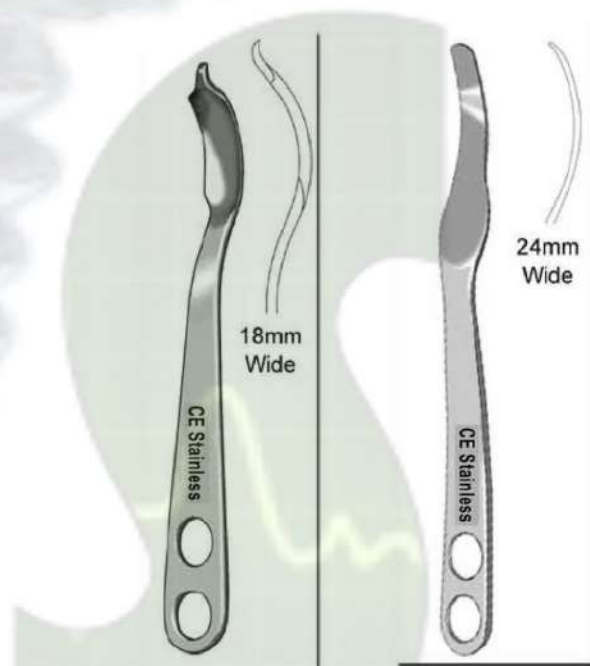

22-354-23
Humeral Head
Retractor
23cm / 9"

22-355-26
Pelvic Retractor
Single Prong
A: 26cm / 10 1/2"



22-356-30
Murphy Bone Skid
30cm / 12"

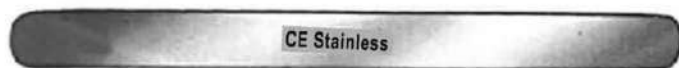

22-357-00
Ribbon Retractor Malleable
30cm / 12"

A: 6" X 6mm
B: 6" X 12mm
C: 6" X 16mm
D: 6" X 19mm
E: 7 1/2" X 25mm

F: 8" X 6mm
G: 8" X 10mm
H: 8" X 12mm
I: 8" X 16mm
J: 8" X 19mm

K: 13" X 19mm
L: 13" X 30mm
M: 13" X 38mm
N: 13" X 45mm
O: 13" X 50mm
P: 13" X 65mm
Q: 13" X 75mm

Sizes Available

RETRACTORS - BONE LEVERS

22-358-00
St. Mark's Pelvic Retractor
Angled Blade

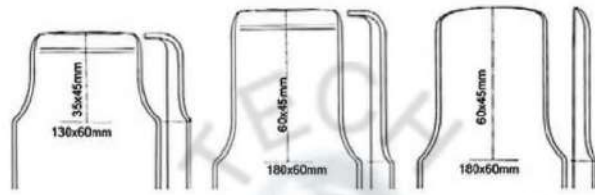

A: 29cm / 11 1/2"
With Lip

B: 33cm / 13"
With Lip

B: 33cm / 13"
Without Lip

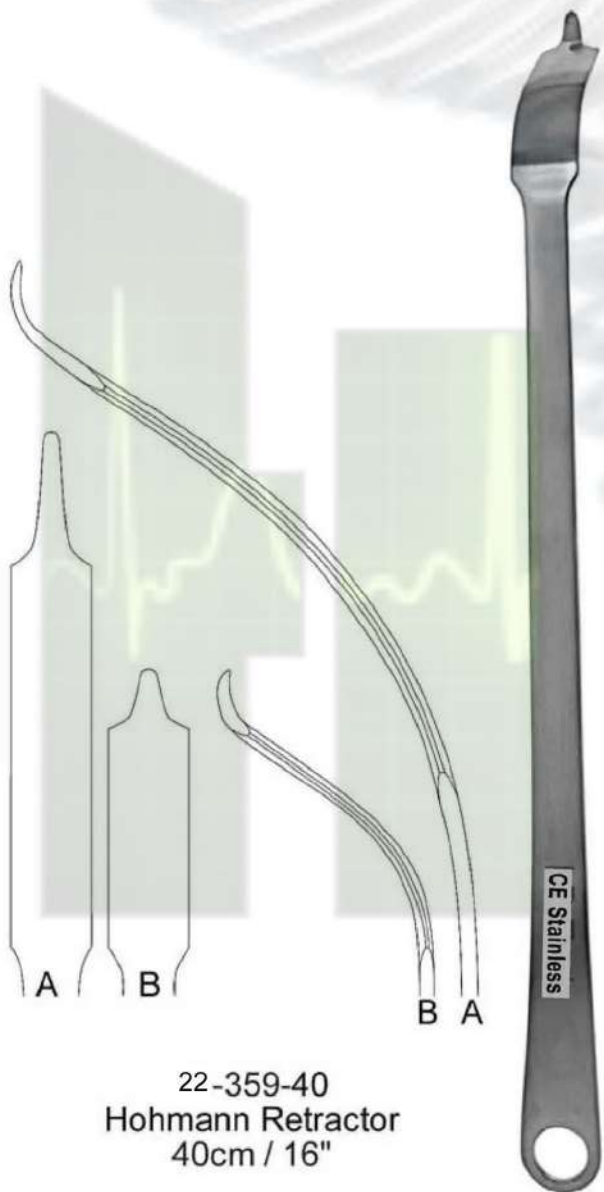

22-359-40
Hohmann Retractor
40cm / 16"

- A: 22mm Blade
2 Finger Rings Long Round → 
- B: 22mm Blade
1 Finger Ring Short Round → 

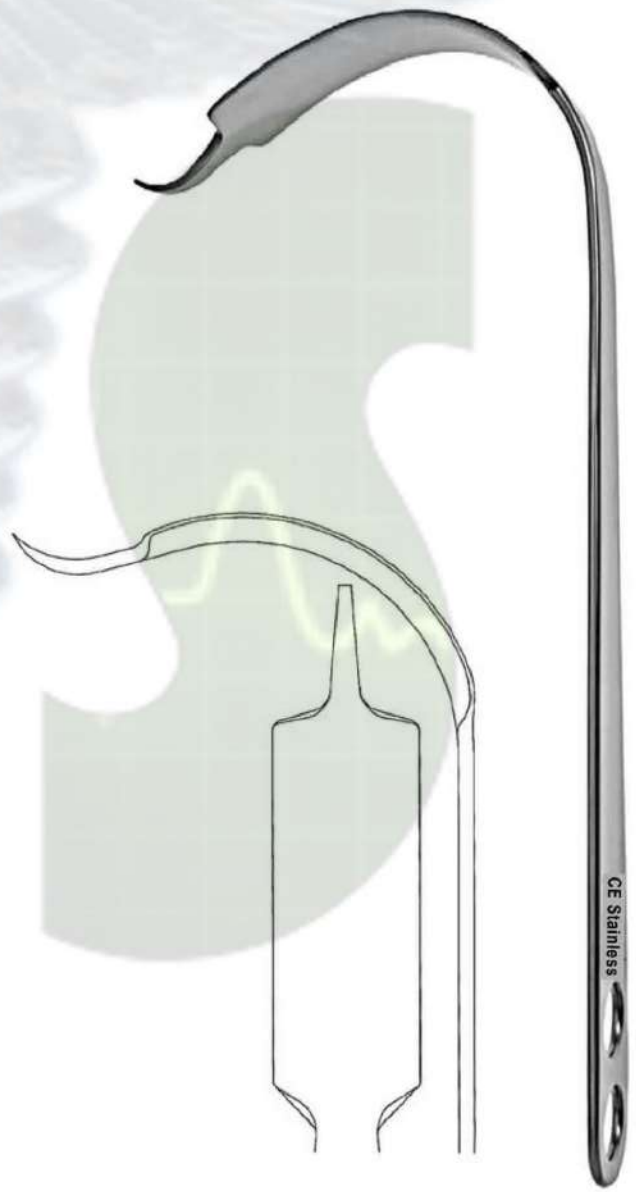

22-360-33
Hohmann Retractor
33cm / 13"
40mm Blade Width

CHISELS - GOUGES - OSTEOTOMES

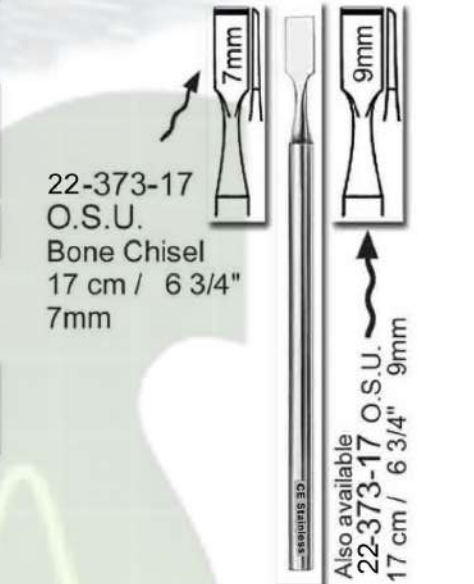
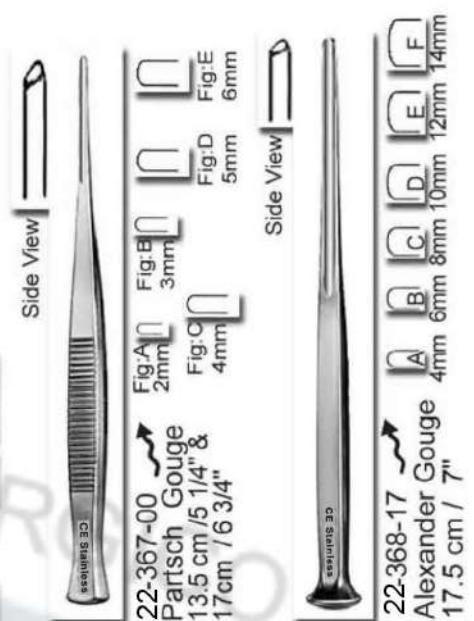
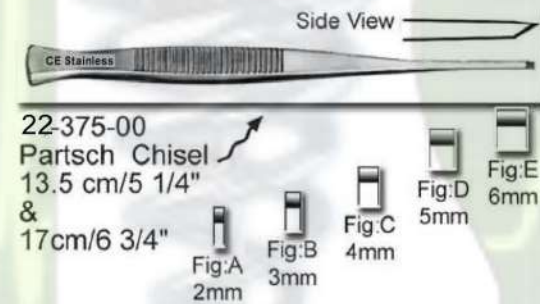
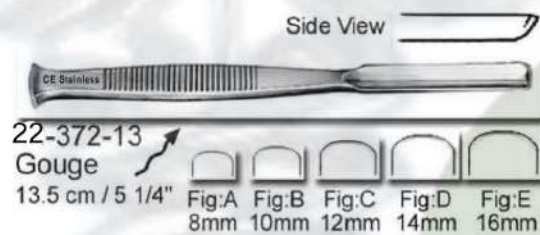
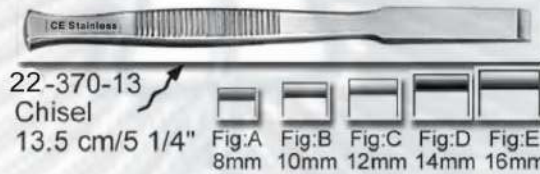
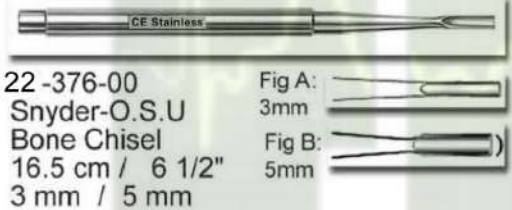
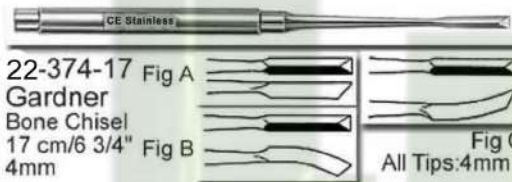
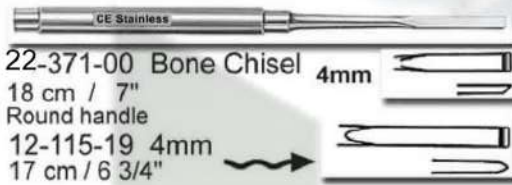
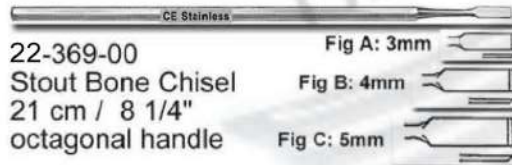
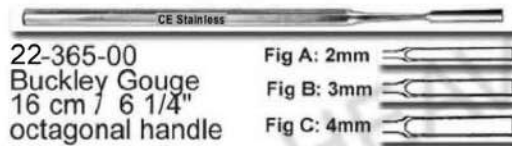
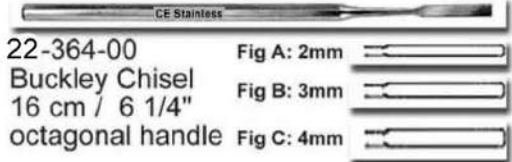

TIP

Three sizes in Lambotte Mini Osteotome (see below)

Available Tip Sizes: 2mm/3mm/4mm/6mm/8mm/10mm/12mm/15mm

Side View

CE Stainless

2mm/3mm/4mm/6mm/8mm/10mm/12mm/15mm

-377-12 (12.5 cm / 5")
Lambotte, Mini Osteotome

30-377-17 (17 cm / 6 3/4")
Lambotte, Mini Osteotome
3mm / 4mm / 6mm /
8mm / 10mm / 12mm / 15mm

-377-24 (24 cm / 9 1/2")
Lambotte, Osteotome
15mm / 20mm / 25mm /
30mm / 38mm / 44mm / 50mm

Available in
15mm
20mm
25mm
30mm
38mm
44mm
50mm

30-378-24
Lambotte,
Osteotome

Other Lambotte
Mini Osteotomes
sizes / Tips

For Image,
please see photo
of above
Osteotome.

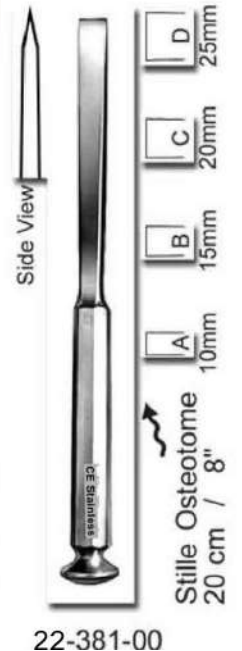
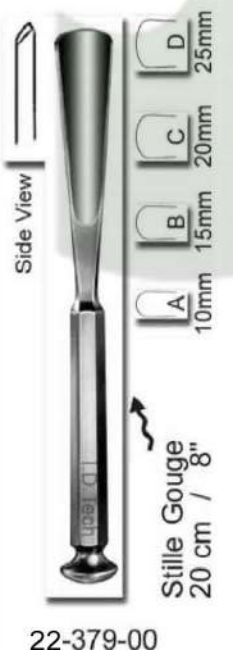

CHISELS - GOUGES - OSTEOTOMES

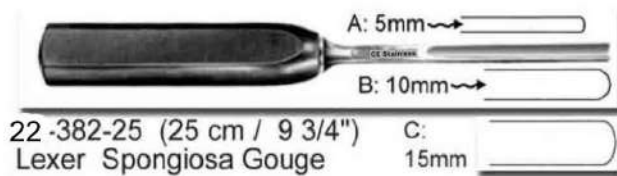

22-382-25 (25 cm / 9 3/4")
Lexer Spongiosa Gouge

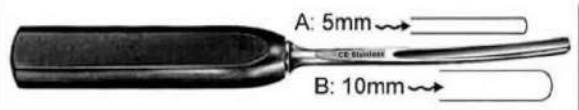

22-384-25 Lexer Spongiosa
Gouge
25 cm / 9 3/4"



22-386-18
Lexer, Mini Osteotome
18.5 cm / 7 1/4"



22-388-18
Lexer, Mini Gouge
18.5 cm / 7 1/4"



22-390-22 Lexer,
Osteotome
22 cm / 8 3/4"



22-392-22
Lexer, Gouge
22 cm / 8 3/4"



22-394-18
Vickers Spongiosa Gouge
18 cm / 7"



22-397-18 US Army Chisel 18 cm / 7"

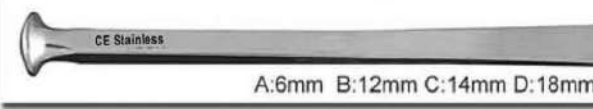

22-399-18 US Army Osteotome 18 cm / 7"

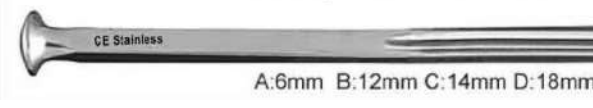

A:6mm B:12mm C:14mm D:18mm



22-383-20
Smith-
Petersen
Osteotome
20.5 cm/8"

Available Tips
6mm
9mm
13mm
16mm
19mm
25mm
32mm

TIP



22-385-20 Smith-Petersen
Osteotome
20.5 cm / 8"

6mm / 9mm / 13mm /
16mm / 19mm / 25mm / 32mm

TIP

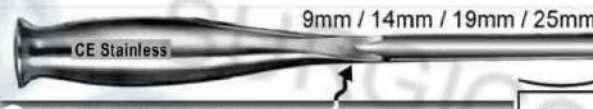

22-387-20 Smith-Petersen Gouge
20.5 cm / 8"

TIP



22-389-20 Smith-Petersen Gouge
20.5 cm / 8"

9mm / 14mm / 19mm / 25mm

TIP



22-391-17 Hoke Osteotome
17 cm / 6 3/4"

3mm / 5mm /
6mm / 8mm / 9mm

TIP



22-393-24 Hibbs Osteotome
24.5 cm / 9 3/4"

6mm / 13mm / 19mm / 25mm / 32mm

TIP



22-395-24 Hibbs Chisel
24.5 cm / 9 3/4"

6mm / 13mm / 19mm / 25mm / 32mm

TIP



22-396-24 Hibbs Gouge
24.5 cm / 9 3/4"

6mm / 13mm / 19mm / 25mm / 32mm

TIP



22-398-16 Sheehan Osteotome 16cm / 6 1/2"



CHISELS - GOUGES - OSTEOTOMES

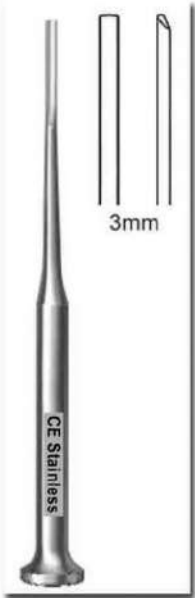

22-402-21
Shoulder Penetrating
Gouge 21cm/8 1/2"

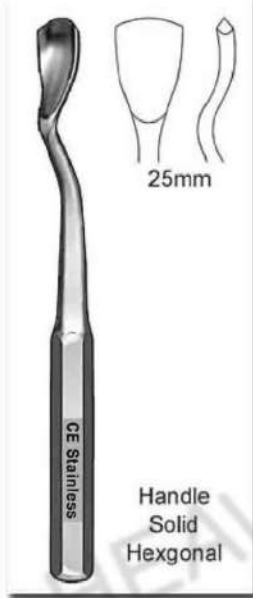

22-403-23
Swan Neck
Gouge 23cm/9"

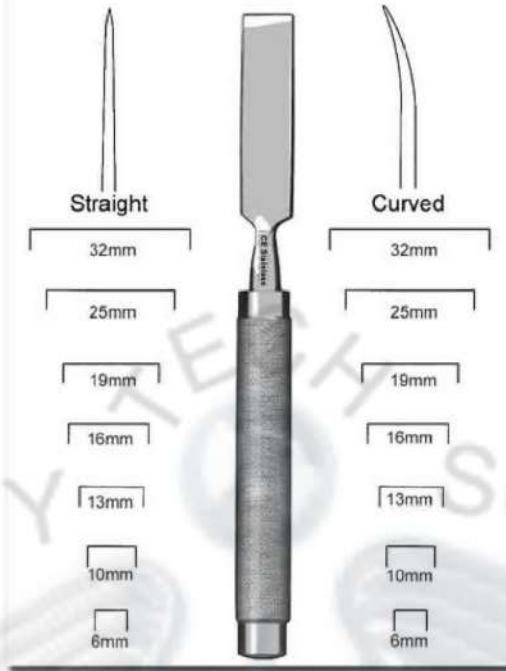

22-404-00
Cobb Osteotome 28cm/11"

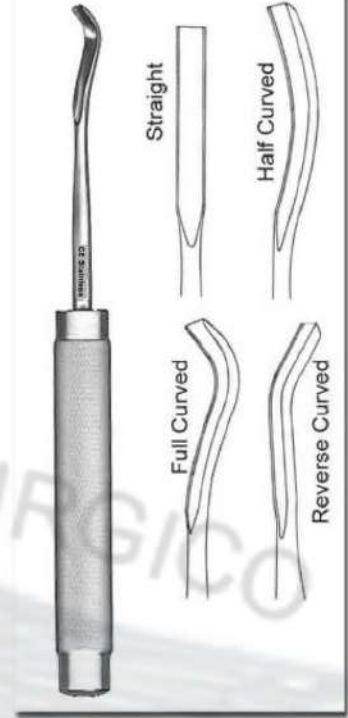

22-405-00
Cobb Gouge 28cm/11"

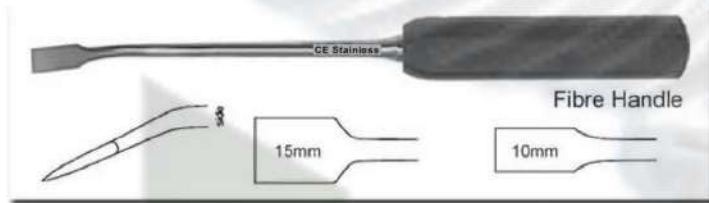

22-406-00 Lexter Osteotome Angled / 28cm/11"



22-407-00 Cinelli Osteotome 15.5cm/6 1/2"

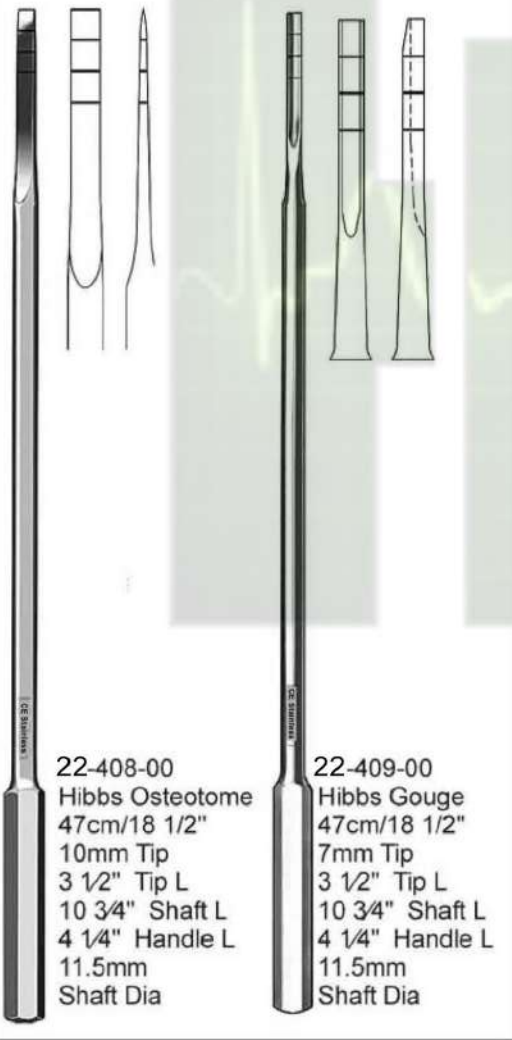

22-408-00
Hibbs Osteotome
47cm/18 1/2"
10mm Tip
3 1/2" Tip L
10 3/4" Shaft L
4 1/4" Handle L
11.5mm
Shaft Dia

22-409-00
Hibbs Gouge
47cm/18 1/2"
7mm Tip
3 1/2" Tip L
10 3/4" Shaft L
4 1/4" Handle L
11.5mm
Shaft Dia



22-410-24
Spinal Fusion
Gouge
24cm/9 1/2"
6mm Tip

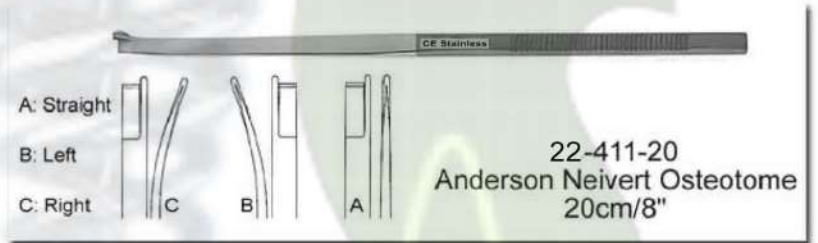

22-411-20
Anderson Neivert Osteotome
20cm/8"

Set Includes:
5 Chisels
5/10/15/25mm
5 Osteotomes
5/10/15/25mm
3 Gouges
50/60/70mm Radius
1 Handle Fibre
1 Key

Chisel Handle Fibre w/Chisel - Osteotome - Gouge Blades
18.5cm/7 1/4"

22-412-18

22-413-18 (18.5 cm / 7 1/4")
 Volkmann Bone Curette
 oval with plastic handle

Available Sizes:
 D0000 □000 □00 □0 □1
 2 3 4 5 6



22-415-00 A / B / C
 Volkmann Bone Curette,
 double-ended (oval / round).

Available in 3 sizes (Length)
 A: 13 cm / 5"
 B: 16 cm / 6 1/4"
 C: 20 cm / 8"



22-418-21 Bone Curette,
 double-ended (round / oval) 21 cm / 8 1/4"



22-420-17 Schede Bone Curette
 17 cm / 6 3/4" oval with hollow handle



22-422-17 Volkmann Bone Curette
 17 cm / 6 3/4" oval, with hollow handle



22-424-17 Bruns Bone Curette
 17 cm / 6 3/4" Round, with hollow handle



22-426-17
 Spratt Bone Curette
 17 cm / 6 3/4"
 Oval, with hollow handle



22-428-13 A / B / C
 Williger Bone Curette,
 double-ended 13.5 cm / 5 1/4"

Available in 3 sets of combination



22-430-17 A / B / C Williger
 Bone Curette, 17 cm / 6 3/4"
 double-ended oval / oval

A: 00/00 ●/●
 B: 0/0 ●/●
 C: 1/1 ●/●



22-414-27 (27.5 cm / 10 3/4")
 Volkmann Bone Curette
 oval with plastic handle

□0 □1 □2 □3



22-416-23 Bruns Bone Curette
 23 cm / 9" oval, solid



22-417-25 A / B / C
 Scoville Bone Curette
 25 cm / 9 3/4"
 oval, with hollow handle



22-419-25 Simon Bone Curette
 25 cm / 9 3/4"
 oval, with hollow handle



22-421-16 Modell USA
 Bone Curette 16 cm / 6 1/4"
 Oval, with hollow handle



22-423-15 Modell USA
 Bone Curette 15.5 cm / 6"
 Oval, with hollow handle



22-425-15 Modell USA
 Bone Curette 15.5 cm / 6"
 Oval, with hollow handle



22-427-21 Halle Bone Curette
 21 cm / 8 1/4" oval, malleable shaft,
 with hollow handle



30-431-00 A / B / C
 Volkmann
 Bone Curette,
 double-ended



22-429-00 A / B / C
 Hemingway-Martin
 Bone Curette, double-ended
 18.5 cm / 7 1/4"
 octagonal handle oval / oval

Available in 3 sets of
 same order faces

A: 1 R/L ●/●
 B: 2 R/L ●/●
 C: 3 R/L ●/●

For 18cm:30-429-00 A / B / C (3 same order sets)
 Hemingway Bone Curette, double-ended 18 cm/7"
 octagonal handle oval / oval (For illustration see 12-374-18)



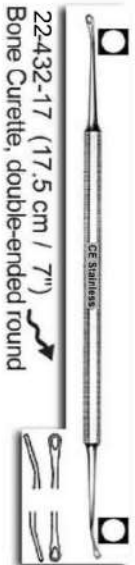

22-432-17 (17.5 cm / 7") Bone Curette, double-ended round



22-433-18 A / B / C Hemingway Bone Curette, double-ended, round / round 18.5 cm / 7 1/4" octagonal handle

Available in 3 sets of same order faces
 A: 00/00 ● / ●
 B: 0/0 ● / ●
 C: 1/1 ● / ●



22-435-18 A / B / C / D Lucas Bone Curette, double-ended 18 cm / 7" octagonal handle

Available in 4 sizes

A: 1 R/L
 B: 2 R/L
 C: 3 R/L
 D: 4 R/L

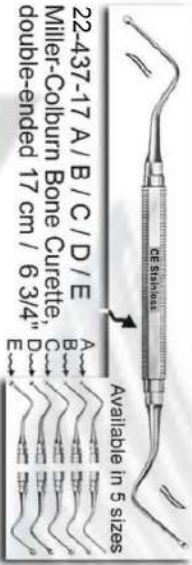

22-437-17 A / B / C / D / E Miller-Colburn Bone Curette, double-ended 17 cm / 6 3/4"

Available in 5 sizes

A
 B
 C
 D
 E



22-439-17 A / B / C / D / E Molt Bone Curette 17 cm / 6 3/4"

Available in 5 sizes

A B C D E



22-441-19 Molt Bone Curette 19 cm / 7 1/2" Round Handle

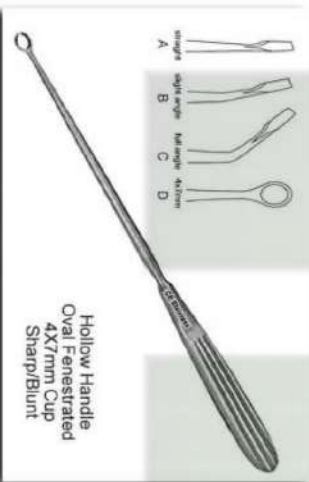

Hollow Handle
 Oval Fenestrated
 4X7mm Cup
 Sharp/Blunt

22-443-23 Semmes Ring Curette 23 cm / 9"

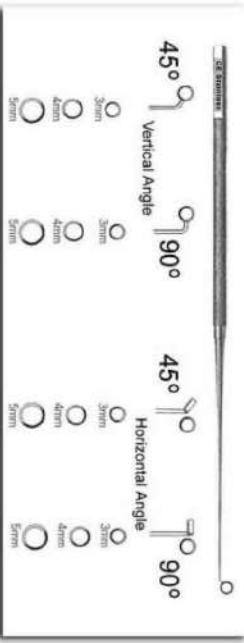

22-434-18 Ray Pituitary Curette 18 cm / 7 1/2"

Vertical Angle 45° 90° Horizontal Angle 45° 90°

3mm
 4mm
 5mm
 3mm
 4mm
 5mm

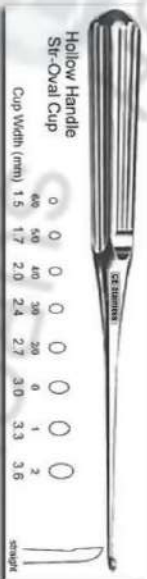

Hollow Handle Str-Oval Cup

Cup Width (mm) 1.5 1.7 2.0 2.4 2.7 3.0 3.3 3.6

22-436-18 Lempert Curette 18 cm / 7 1/2"



Hollow Handle Reverse Up Angle Oval Cup

Cup Width (mm) 2.5 2.8 3.3 4.0 4.5 5.5 7.5 8.5 10

22-438-18 Epstein Curette 18 cm / 7 1/2"



Hollow Handle Oval Cup

3mm 4mm 5mm
 Cup Width (mm) 3.6 4.4 5.2 6.0
 3mm 4mm 5mm

22-440-25 Bushie Curette 25 cm / 10"



Solid Handle Str-Oval Cup

Cup Width (mm) 2.5 2.8 3.3 3.8 4.8 5.8 7.2 8.7 10.5

22-442-28 Spinal Fusion Curette 28 cm / 11"



Hollow Handle
 Oval Fenestrated
 Cup
 Sharp/Blunt

22-445-00 Ring Curette

A: 25 cm / 10" #0 6mm Cup
 B: 25 cm / 10" #2 8mm Cup
 C: 26 cm / 10 1/2" #6 14mm Cup
 D: 28 cm / 11 1/2" #0 6mm Cup
 E: 28 cm / 11 1/2" #2 8mm Cup

22-444-25 Scoville Curette



Reverse Angle
 4.7mm
 Cup Width
 90° Up

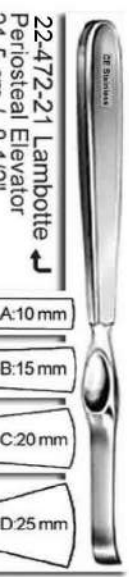
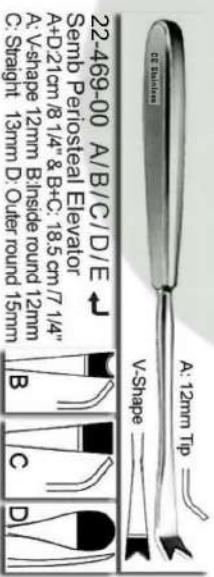
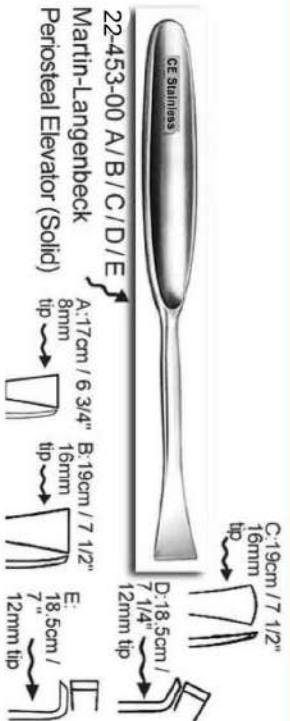



22473-20 Periosteal Elevator
20 cm / 8" with plastic handle



22475-17 A / B Periosteal Elevator
17 cm / 6 3/4" with hollow handle

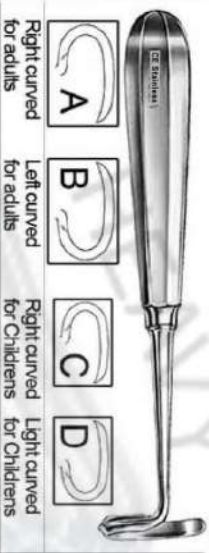

Right curved for adults Left curved for adults Right curved for Childrens Light curved for Childrens

22477-17 A / B / C / D Doyen Rib Raspatory
17.5 cm / 7" Rib Raspatories with hollow handle



22479-18 West Periosteal Elevator,
double-ended 18.5 cm / 7 1/4"
octagonal handle



22481-17 Williger Elevator
17 cm / 6 3/4" 7mm tip



22483-16 Williger Elevator
16 cm / 6 1/4" (5.5mm tip)



22485-17 Elevator
17 cm / 6 3/4" Light weight



22-487-14 McKenty Elevator
14 cm / 5 1/2"

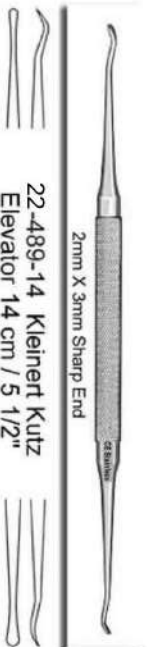

22-489-14 Kleinent Kutz
Elevator 14 cm / 5 1/2"



22-474-17 Vickers Dissector
17 cm / 6 3/4"

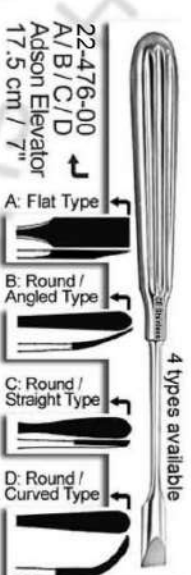

22476-00
A/B/C/D
Adson Elevator
17.5 cm / 7"

4 types available
A: Flat Type
B: Round / Angled Type
C: Round / Straight Type
D: Round / Curved Type



22-478-19 A / B
Langenbeck Elevator
19.5 cm / 7 3/4"

B: 10mm A: 8mm



22-480-17 A / B / C / D
Martin Langenbeck Elevator
17 cm / 6 3/4" except D

A: 5 mm B: 7mm C: 8mm D: 10mm



22-482-16 Phalangeal Elevator
16 cm / 6 1/4"



22-484-21 Alderlyce
Dissector, double-ended
21 cm / 8 1/4"



22-486-18 McDonald
Dissector, double-ended
18.5 cm / 7 1/4"



22-488-19 Freer Elevator
19 cm / 7 1/2"

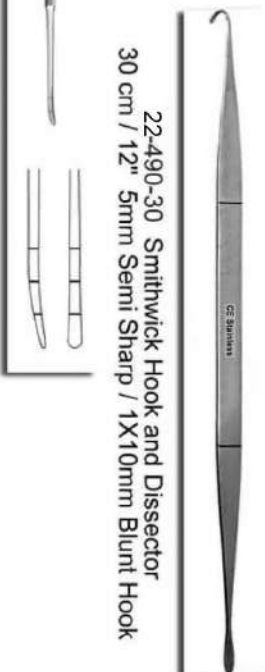

22-490-30 Smithwick Hook and Dissector
30 cm / 12" 5mm Semi Sharp / 1X10mm Blunt Hook



22-491-38 Penfield Elevator Endoscopic

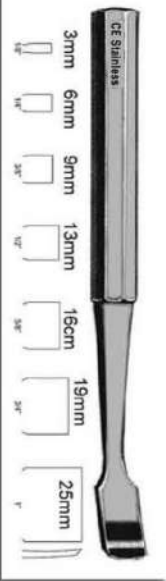

22-492-19 Key Elevator 19 cm / 7 1/2" Sharp Edge

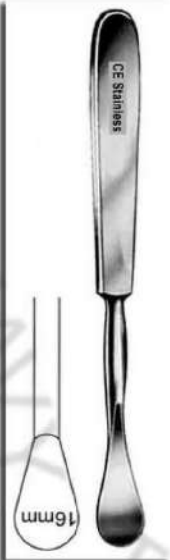

22-494-18 Sedillot Elevator 18 cm / 7" Sharp Edge



22-495-17 Kirrmission Periosteal Respiratory 17 cm / 6 3/4"



22-493-16 Sayre Elevator 16 cm / 6 1/2"
A: Sharp / Blunt B: Blunt/ Blunt

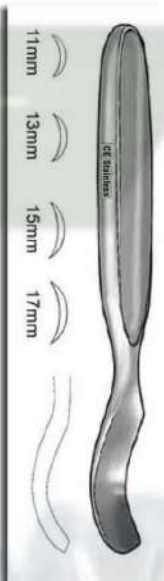

22-498-16 McGlamry Metatarsal Elevator
16 cm / 6 1/2" Sharp



22-499-19 Crego Periosteal Elevator
19 cm / 7 3/4" Sharp
A: 14mm Full Curves B: 14mm Slight Curves
C: 7mm Full Curves D: 7mm Slight Curves



22-500-00 Chandler Elevator Blunt
A: 19cm / 7 1/2" 13mm B: 20cm / 8" 19mm
C: 23cm / 9" 25mm D: 25.5cm / 10" 30mm

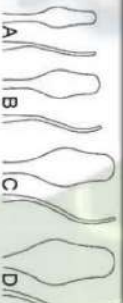

22-501-00 Darrach Elevator Blunt
Small
A: 26cm / 10 1/4" 13mm Width at Tip
Medium
B: 26cm / 10 1/4" 20mm Width at Tip
Large
C: 35cm / 13 3/4" 25mm Width at Tip

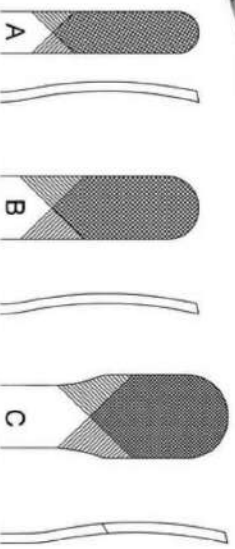
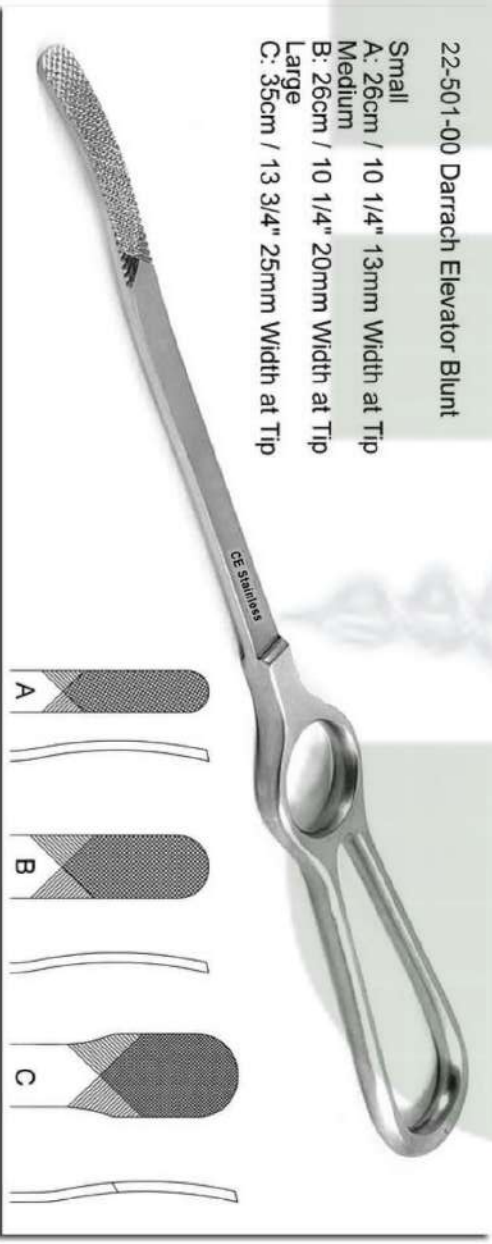



22-502-24 Cobb Spinal Elevator Sharp
24cm / 9 1/2" Hexa Handle

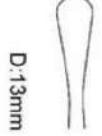
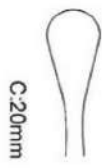

Also Available
in Fibre Handle
with Same
Sizes
of Blades



22-504-28 Cobb Spinal Elevator Sharp
28cm / 11" Knurled Handle



22-505-00 Cobb Elevator Endoscopic Sharp / Fibre Handle



A: 43cm / 17"
6mm Tip Width
2.7" Tip Length
9.3" Shaft Length
5" Handle Length
7.2mm Shaft Dia

B: 50cm / 20"
6mm Tip Width
3 1/2" Tip Length
10" Shaft Length
6 1/2" Handle L
11.5mm Shaft Dia

C: 50cm / 20"
10mm Tip Width
3 1/2" Tip Length
10" Shaft Length
6 1/2" Handle L
11.5mm Shaft Dia

D: 50cm / 20"
13mm Tip Width
3 1/2" Tip Length
10" Shaft Length
6 1/2" Handle L
11.5mm Shaft Dia



22-506-43 Rib Elevator Endoscopic Sharp / Fibre Handle
43cm / 17" - 9mm Tip Radius - 4" Tip Length
8" Shaft Length - 5" Handle Length
11.5mm Shaft Dia

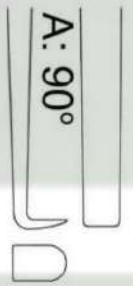

22-507-33 Wagner Elevator Sharp / Fibre Handle
33cm / 13"
A: 8mm Wide B: 17mm Wide



Note: Handle Shown In Dark Colors are Made of FIBRE Material

22-509-19 Lucae Mallet 19.5cm / 7 3/4"



Available in 2 sizes
19mm Ø / 230 gms
25mm Ø / 260 gms

22-510-19 Cottle Mallet Plane / Convex



19cm / 7 1/2" 30mm Ø / 300 gms

22-512-16



20mm Ø / 140 gms
Williger Mallet
16.4cm / 6 1/2"

-514-26 Mallet 26 cm / 10 1/4"



30mm Ø / 510 gms

22-516-19 Mead Mallet 19 cm / 7 1/2"



27mm Ø / 320 gms
with interchangeable plastic disks

22-518-19 Partsch Mallet



22mm Ø / 200 gms

19 cm / 7 1/2" with hollow handle

22-520-26 Mallet 26 cm / 10 1/4"



with lead filling

Also available without lead filling

42mm Ø / 400 gms

22-521-26 Mallet 26 cm / 10 1/4"



without lead filling

42mm Ø / 400 gms

22-523-24 Williger Mallet



24 cm / 9 1/2" lead filled

Available Head Sizes & Approximate Weight
26mm Ø / 300 gms 28mm Ø / 340 gms
30mm Ø / 400 gms

22-508-26 Mallet 30mm Ø / 675 gms
26.5 cm / 10 1/2"



plane (Teflon) / convex (steel)

22-511-26 Mallet 26 cm / 10 1/4"



42 / 30mm Ø / 530 gms

22-513-24 Mallet 24 cm / 9 1/2"



30mm Ø / 480 gms

22-515-24 Mallet 24 cm / 9 1/2"



37mm Ø / 370 gms

Spare facings (Pair)

22-517-22



30mm Ø / 125 gms

Mallet 22 cm / 8 3/4"

22-519-26 Mallet 26.5 cm / 10 1/2"



30mm Ø / 450 gms

22-522-00 A/B/C Doyen Mallet



Available Length / Head Sizes & Approximate Weight
A: 20.5cm / 8" 25mm Ø / 120 gms
B: 21cm / 8 1/4" 30mm Ø / 180 gms
C: 21.5cm / 8 1/2" 35mm Ø / 260 gms



22-524-19 Herbert Mallet 19 cm / 7 1/2"



for ulnar head anthesis

22-527-19 Vickers Mallet 19 cm / 7 1/2"



Teflon disks

25mm Ø / 300 gms

22-526-26 Mallet 26.5 cm / 10 1/2"



50mm Ø / 900 gms

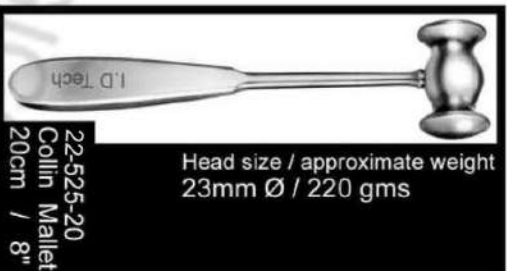

22-525-20 Collin Mallet 20cm / 8"

Head size / approximate weight
23mm Ø / 220 gms

Note: Handle Shown In Dark Colors are Made of FIBRE Material



22-528-20 Kirk Mallet 20cm / 8"
Head Dia 38mm/Weight: 1 lb. 4 oz. (570 grams)



Head Weight: 7 oz (200 grams)

22-529-19 Gerzog Mallet 19cm / 7 1/2"
Head Dia 25mm/Weight 10 oz (285 grams)



Head Weight: 20 oz (567 grams)

22-530-19 Heath Mallet
19cm / 7 1/2"
Head Dia 40mm/Weight 2 lbs. (907gm)



Head Weight: 20 oz (567 grams)

22-533-18 Heath Mallet, SS
18cm / 7" Solid Frame Handle
Head Dia 40mm/Weight 36 oz. (1020gm)



22-536-24 All Fibre Mallet 24cm / 9 1/2"
Head Dia 80X60mm Weight 14oz. (397gm)



Fibre Handle

22-531-19 Cloward Mallet
19cm / 7 1/2"
Head Dia 20mm
Weight 8oz. (227gm)



-532-20 Hajek Mallet
20cm / 8"
Head Dia 27mm
Weight 7oz. (198gm)



Fibre Handle



22-534-20 Narrow Tip Mallet 20cm / 8"
Head Dia 7mm Weight 6oz. (170gm)



22-535-23 Fibre Handle Mallet 23cm / 9"
Head Dia 30mm/Weight 12 oz. (340gm)
Also Available in:
Head Dia 35mm/Weight 1lb 40 oz. (570gm)
Head Dia 40mm/Weight 1lb 90 oz. (708gm)

22-537-28 He-Man Mallet 28cm / 11"
Head Dia 38mm / 24mm

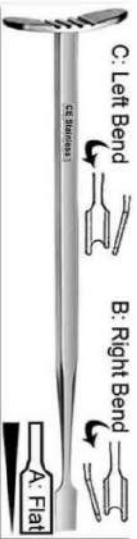

22-538-18 Smilie Meniscus Knife 18 cm / 7"



22-539-18 Meniscus Knife 18 cm / 7"



22-540-22 A/B Neff Meniscus Knife 22 cm / 8 3/4"



22-541-21 A/B Salenius Meniscus Knife 21 cm / 8 1/4" A: Right / B: Left



22-542-15 Bunnell Tendon Stripper 15 cm / 6"



22-543-23 Tendon Stripper 23 cm / 9" Flexible shaft



22-544-33 Tendon Passing Instrument 33.5 cm / 13 1/4"

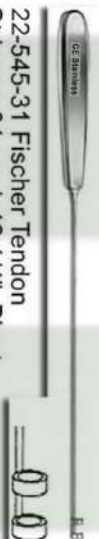

22-545-31 Fischer Tendon Stripper 31 cm / 12 1/4" Blunt



22-546-28 Tendon Stripper 3 / 4 / 5 / 6mm A: 28.5 cm / 11 1/4" B: 60 cm / 24"

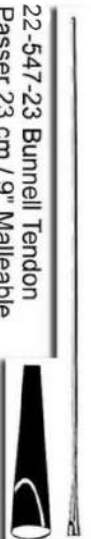

22-547-23 Bunnell Tendon Passer 23 cm / 9" Malleable



22-548-40 Tendon Stripper 40 cm / 16" Fibre Handle



22-549-25 Lowe Breck Cartilage Knife 25 cm / 10" Str Edge-Cvd Blade w/ Guards



22-550-25 Downing Cartilage Knife 25 cm / 10" Concave Edge Cvd Blade w/ Guards



22-551-20 Martin Cartilage Scissors 20cm / 8"



Angular Blades

22-552-24 Mueller Capsule Scissors 24cm / 9 1/2"

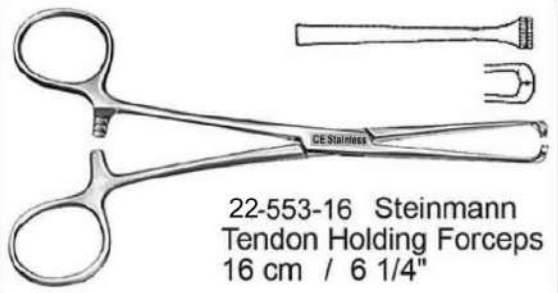

22-553-16 Steinmann
Tendon Holding Forceps
16 cm / 6 1/4"

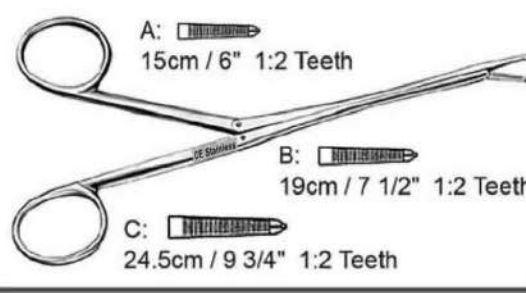

22-554-00 A / B / C
Brand Tendon Tunnelling Forceps

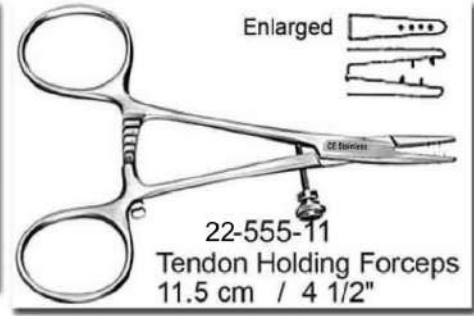

22-555-11
Tendon Holding Forceps
11.5 cm / 4 1/2"

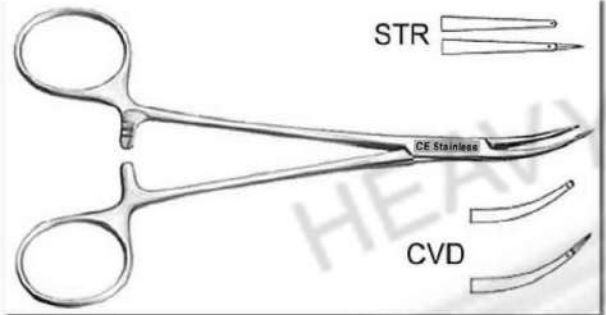

22-556-15 Tendon Interlacing Forceps
15.5 cm / 6" Pointed



22-557-11
Carroll Tendon Holding Forceps 11.5 cm / 4 1/2"

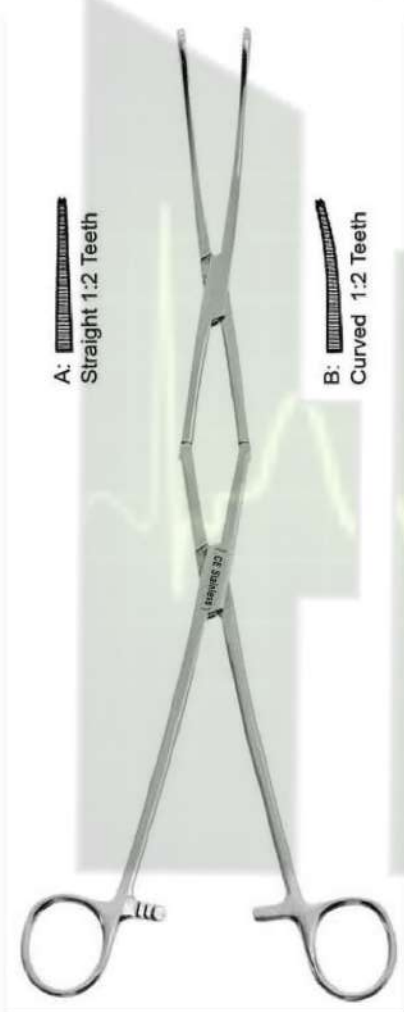

22-558-21
Hallman Tendon Tunnelling Forceps
21 cm / 8 1/4"

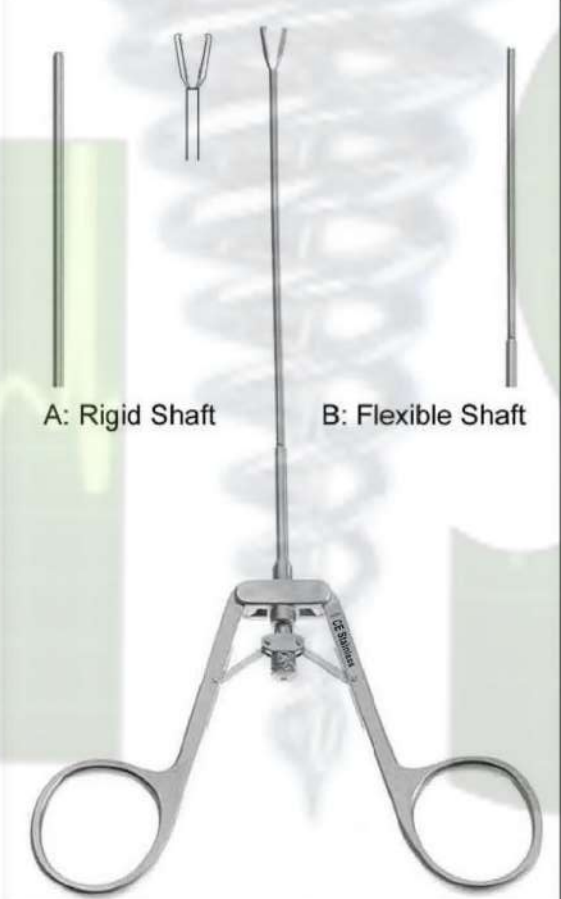

22-559-21
Kleinert-Kutz Tendon Holding Forceps
21 cm / 8 1/4" 1X2 teeth



22-560-14
Hoen Grasping Forceps
14 cm / 5 1/2" (Shaft)
1X2 teeth



22-561-13
Meniscus Clamp
13.5 cm / 5 3/8" 1X2 teeth



22-562-18
Preston Ligamentum Flavum Forceps
(Meniscus) 18.5 cm / 7 1/4"

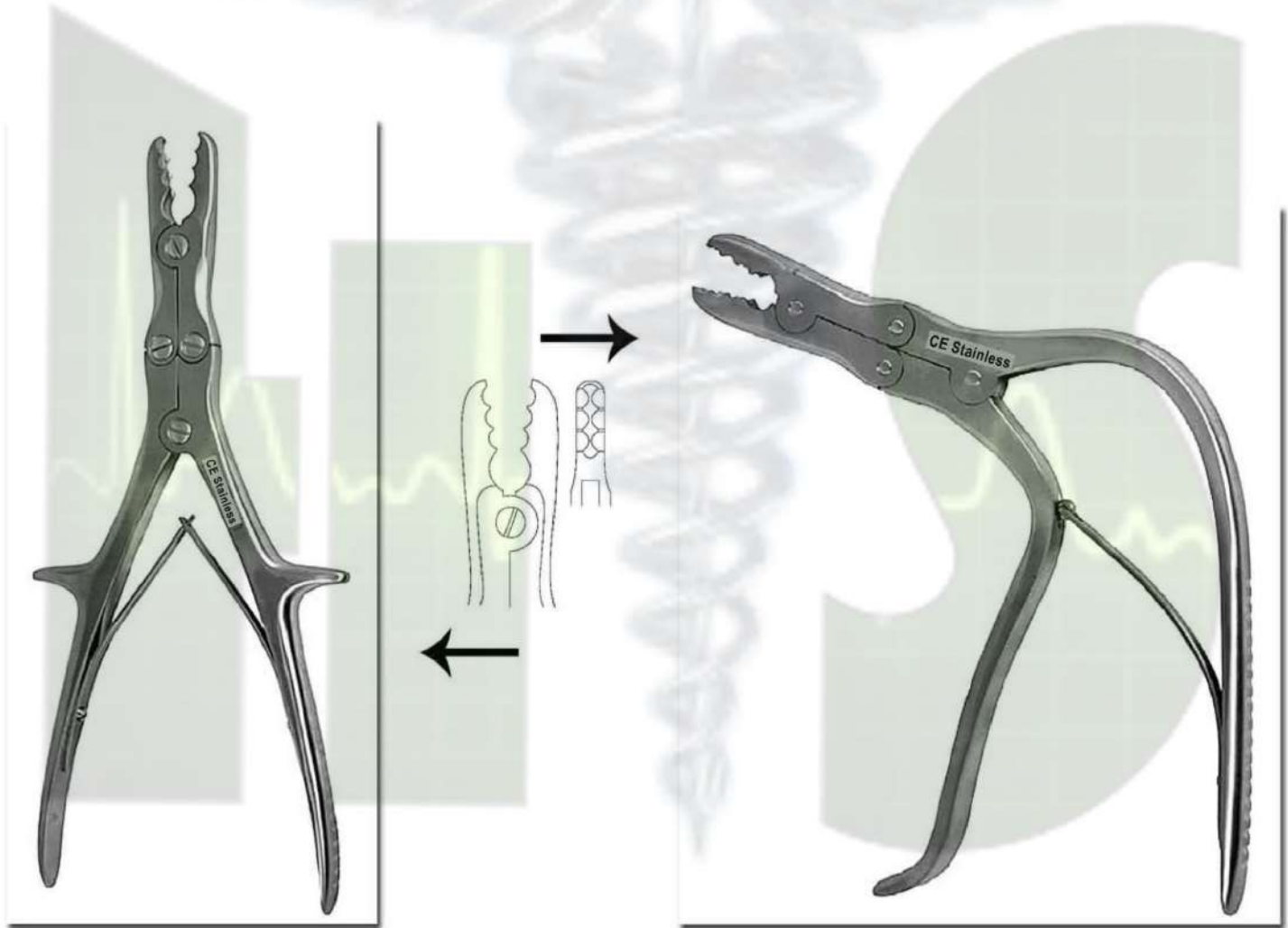

Straight

Angled

22-563-21
Ortho Grasper 21 cm / 8 1/2"
7 X 20 MM Bite

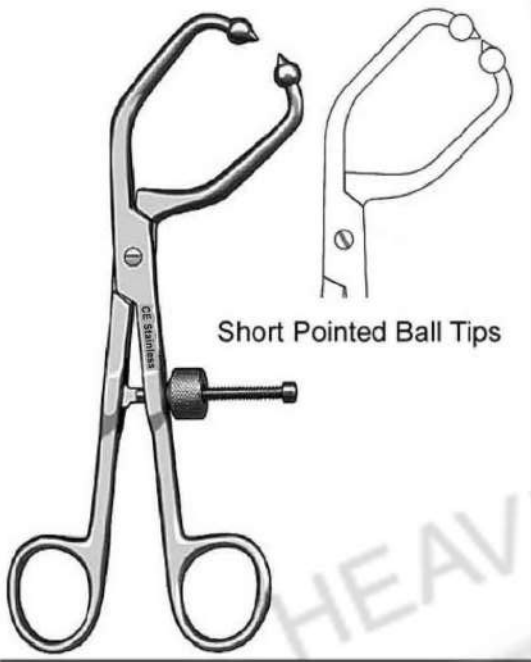

Short Pointed Ball Tips

22-564-19 Pelvic Reduction Forceps
19 cm / 7 3/8" Angular

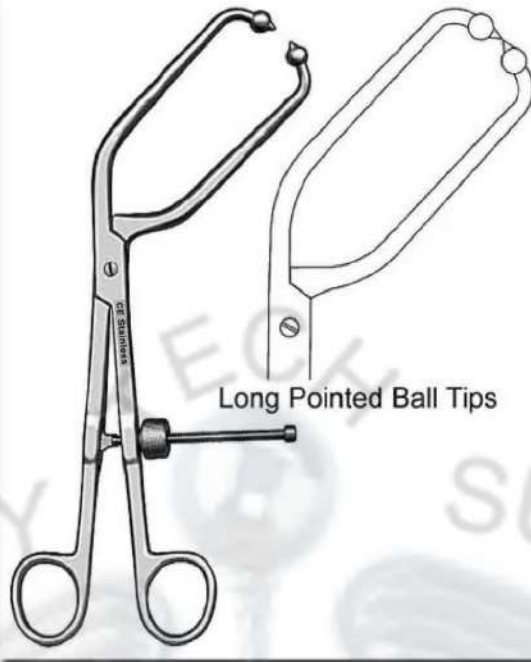

Long Pointed Ball Tips

22-565-24 Pelvic Reduction Forceps
24.5 cm / 9 5/8" Angular

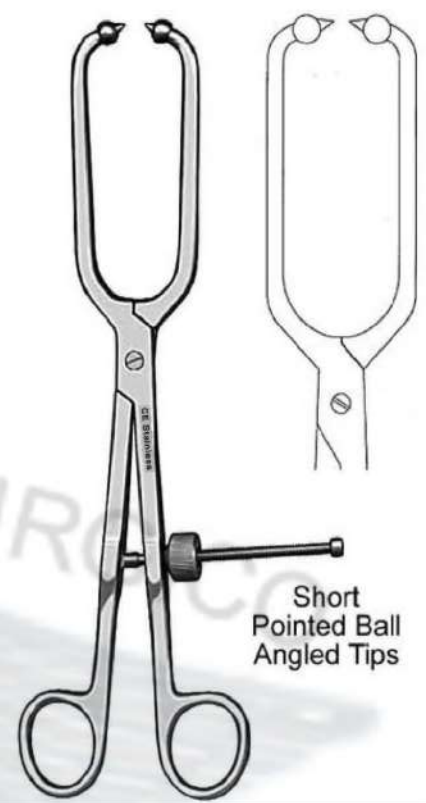

Short Pointed Ball Angled Tips

22-566-25 Pelvic Reduction Forceps
25 cm / 10"

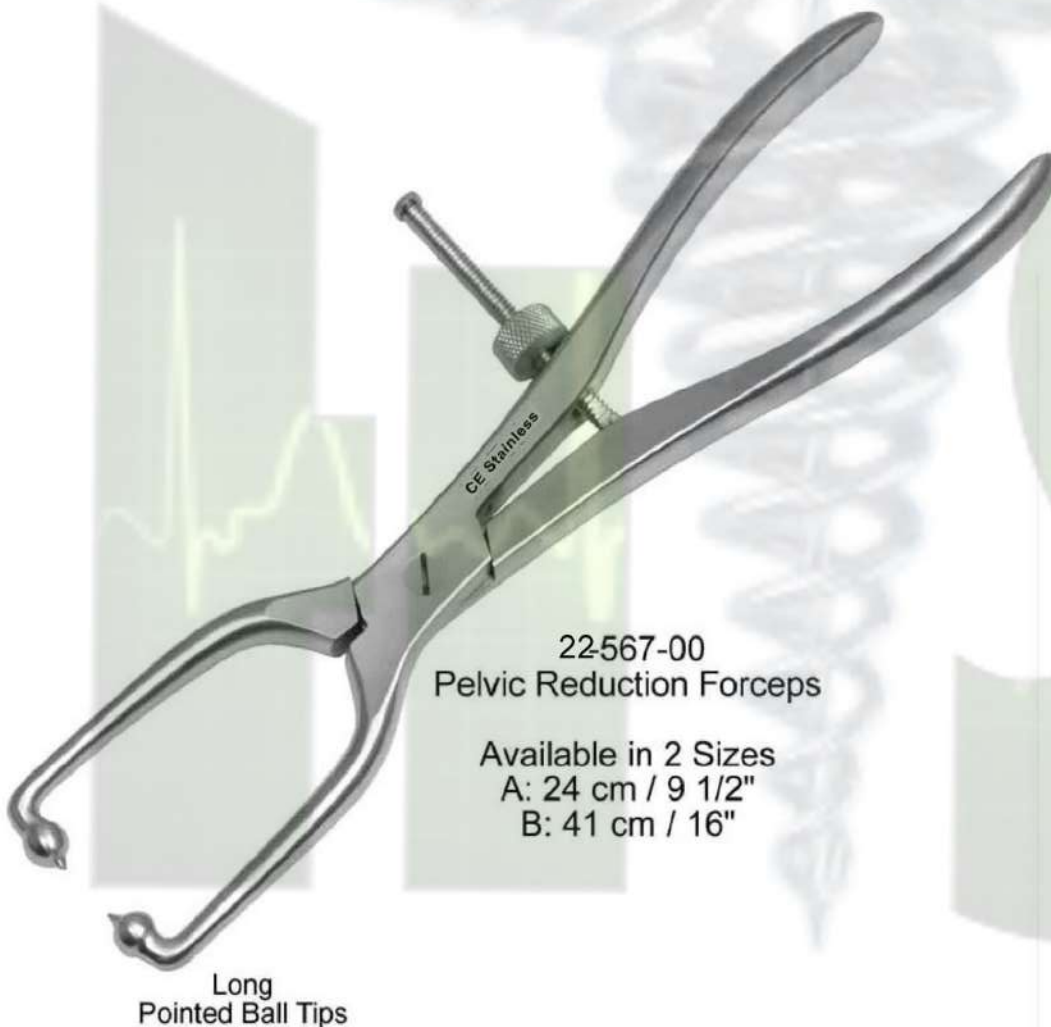

Long Pointed Ball Tips

22-567-00 Pelvic Reduction Forceps

Available in 2 Sizes
A: 24 cm / 9 1/2"
B: 41 cm / 16"

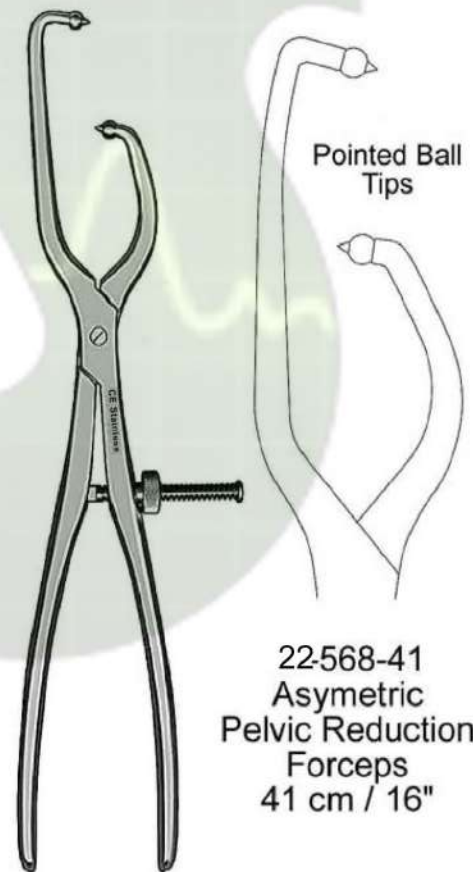

Pointed Ball Tips

22-568-41 Asymmetric Pelvic Reduction Forceps
41 cm / 16"

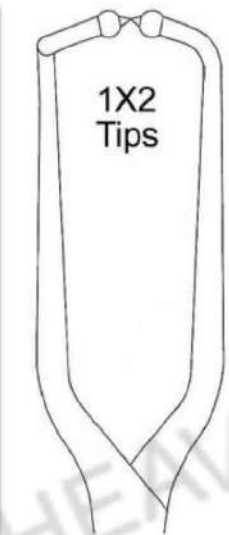

22-569-41
Pelvic Reduction Forceps
Long 1X2
Pointed Ball Tips
41 cm / 16"

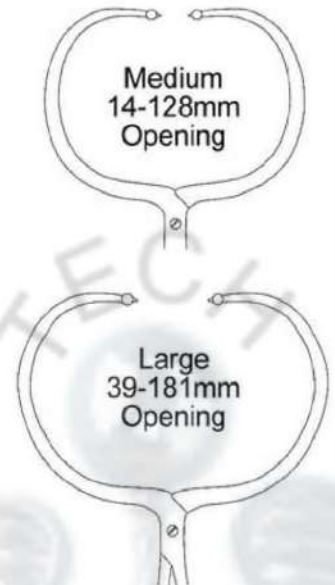

22-570-38
Periarticular
Reduction Forceps
Straight
Pointed Ball Tips
38 cm / 15"



22-571-00
Pelvic
Reduction Forceps
Adjustable Jaws for Screws
A: 25 cm / 10"
B: 33 cm / 13"

BONE HOLDING FORCEPS

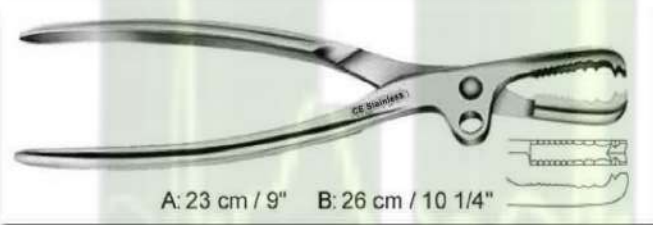
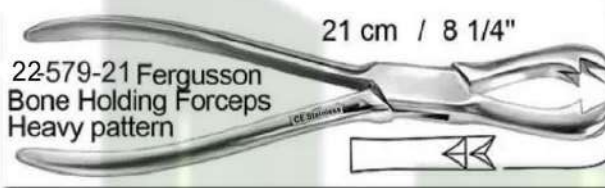

-580-00 Farabeuf Bone Holding Forceps

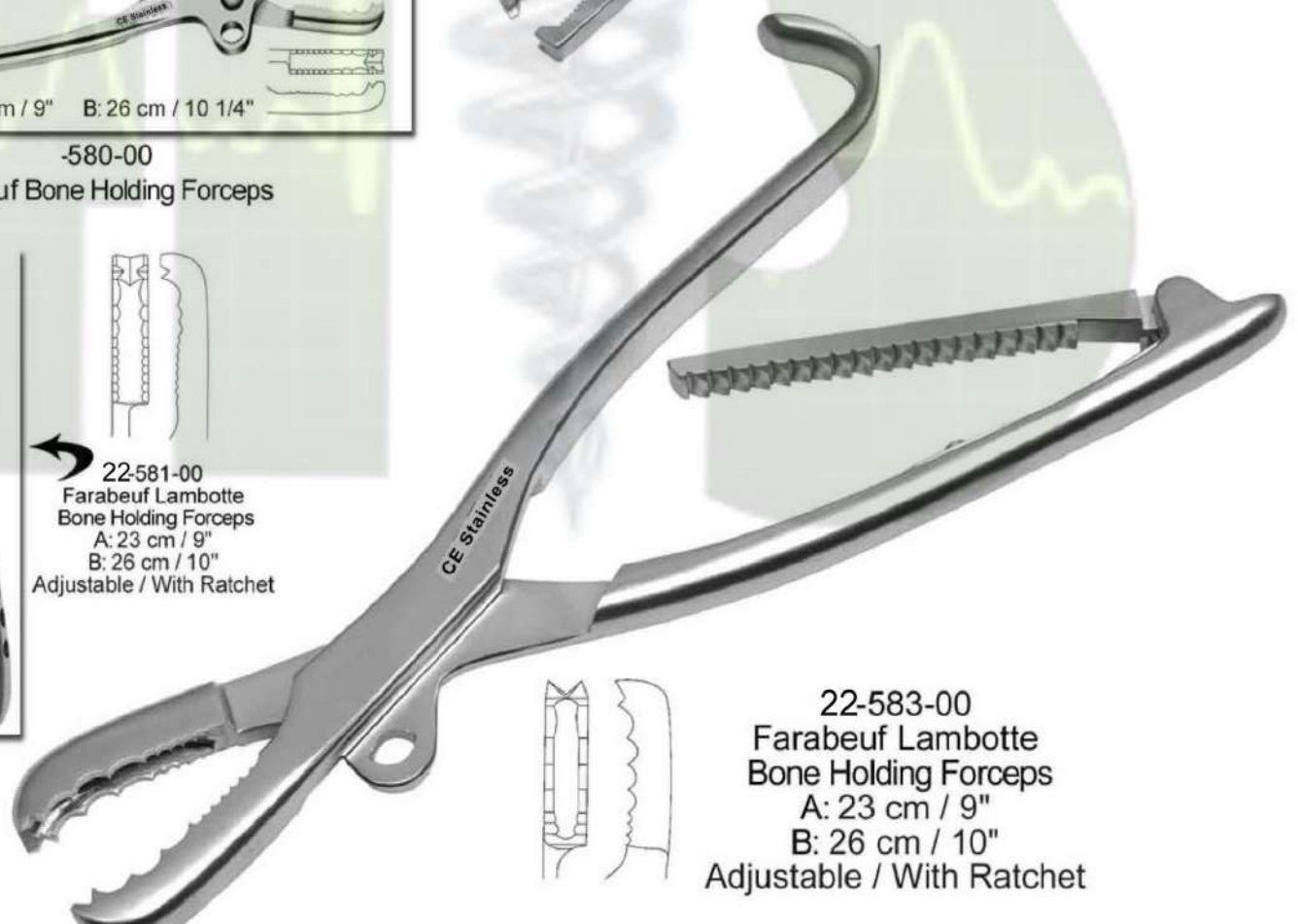
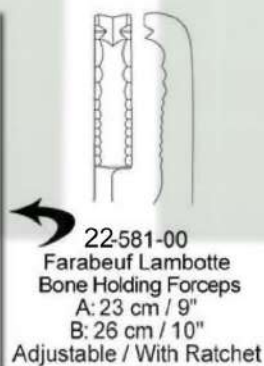

BONE HOLDING FORCEPS

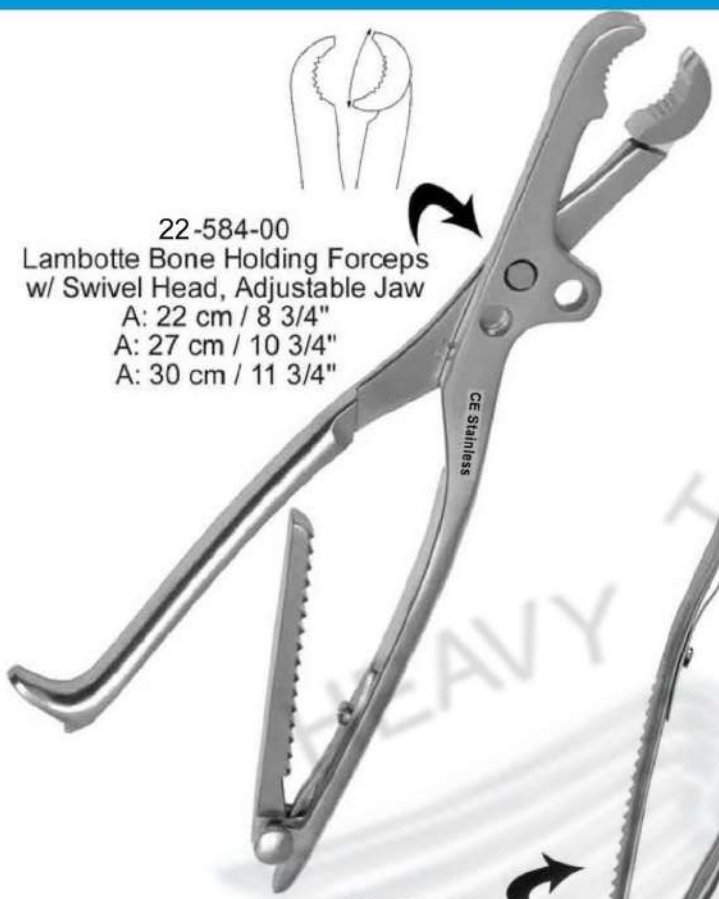

22-584-00
Lambotte Bone Holding Forceps
w/ Swivel Head, Adjustable Jaw
A: 22 cm / 8 3/4"
A: 27 cm / 10 3/4"
A: 30 cm / 11 3/4"

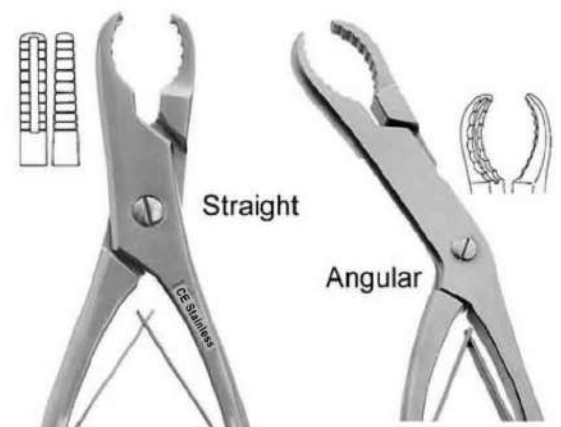

Straight
Angular

22-587-00
Ulrich
Bone Holding
Forceps
w/ Thread Fixation
A: 23 cm / 9"
A: 25 cm / 9 3/4"
A: 28 cm / 11"



22-585-19
Ulrich Bone Holding Forceps
w/ Thread Fixation
19 cm / 7 1/4"



22-586-00
Self Centering
Bone Holding
Forceps
W/ Thread Fixation

Available in:
Available in:
A: 15 cm / 6"
B: 19 cm / 17 1/2"
C: 24 cm / 9 1/2"
D: 26 cm / 10 1/4"
E: 28 cm / 11"

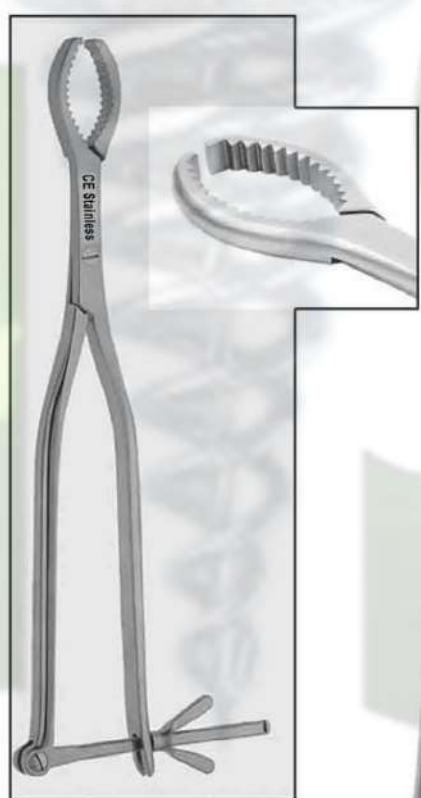

22-588-00
Hey Groves
Bone Holding Forceps
A: 20 cm / 8"
B: 25 cm / 10"

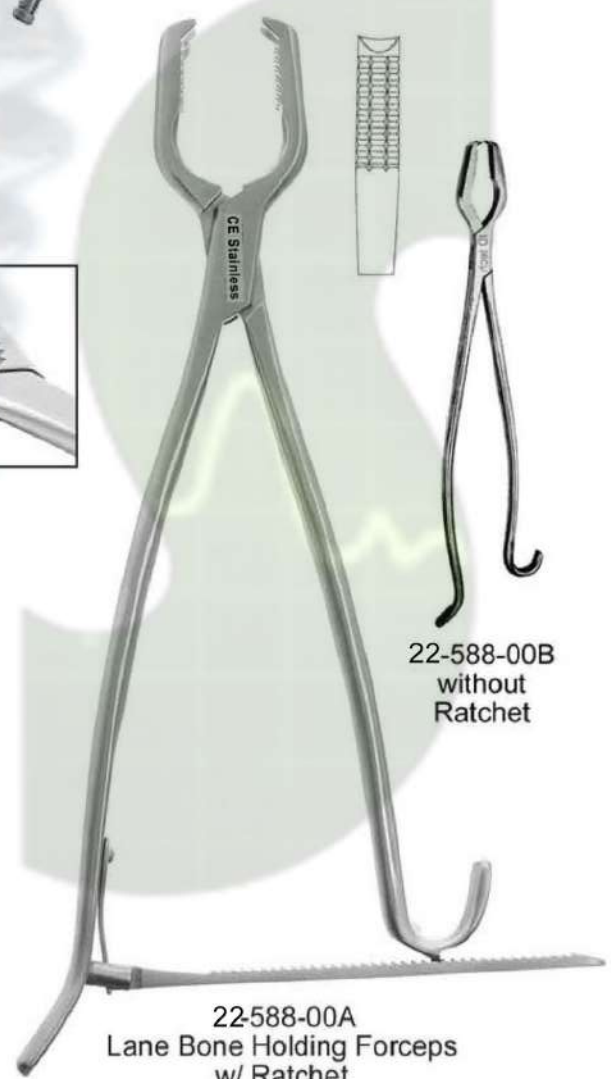

22-588-00A
Lane Bone Holding Forceps
w/ Ratchet
A: 33 cm / 13"
B: 45 cm / 17 3/4"

22-588-00B
without
Ratchet

BONE HOLDING FORCEPS



22-589-00
Verbrugge
Bone Holding Forceps
 A: 17.5 cm / 7"
 B: 25 cm / 9 3/4"
 C: 26 cm / 10 1/4"
 D: 27 cm / 10 3/4"



22-590-23
Smooth Jaws
Bone Holding Forceps
 23 cm / 9"

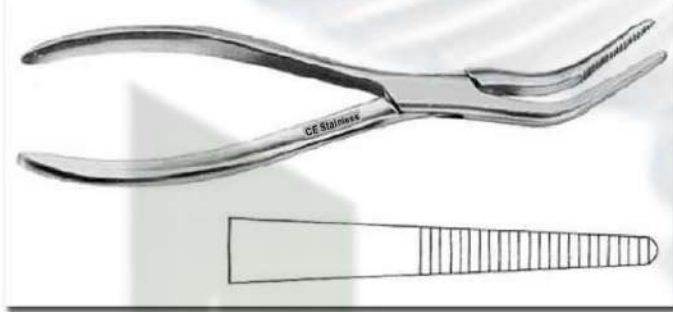

22-591-21
Van Buren Bone Holding Forceps 21.5 cm / 8 1/2"



A:
 17cm
 6 3/4"
 0.9mm

B:
 13cm
 5 1/4"
 1.6mm

22-592-00
Bone Holding Forceps



22-593-23
Angled Bone Holding Forceps
 23 cm / 9"

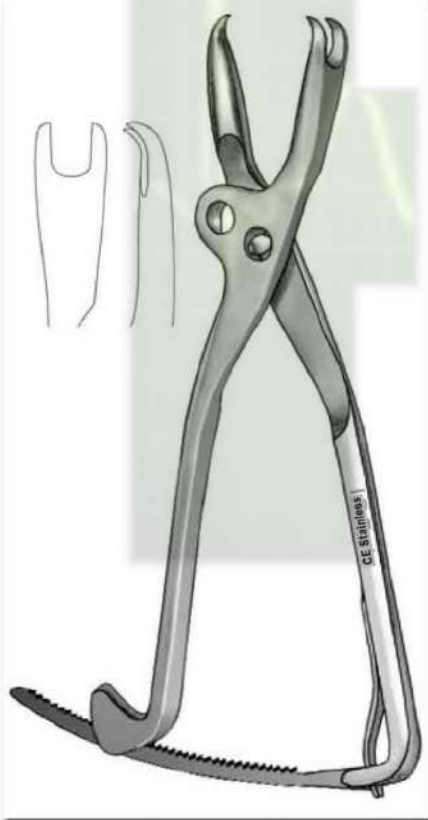

22-594-23
Bishop Bone Holding Forceps

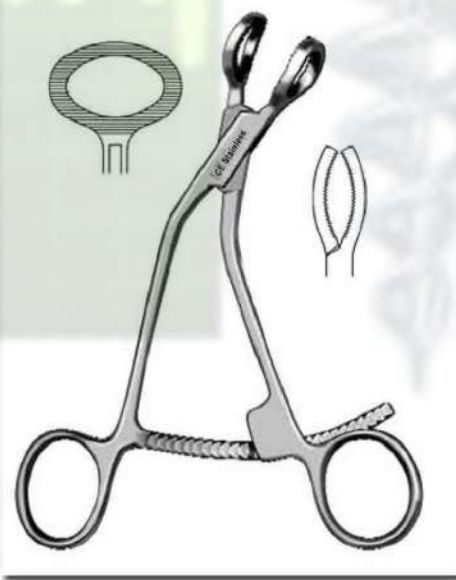

22-595-23
Bishop Bone Holding Forceps

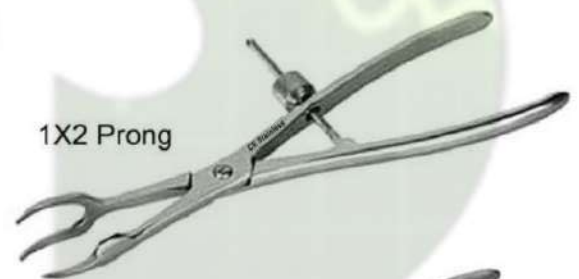

1X2 Prong



2X2 Prong

22-596-18
Patella Forceps
 18 cm / 7"

CARTILAGE REPOSITION FORCEPS



22-602-00
Walton
Cartilage Seizing Forceps
20.5 cm / 8"
A: Straight
B: Upward Cvd
C: Sideward Cvd

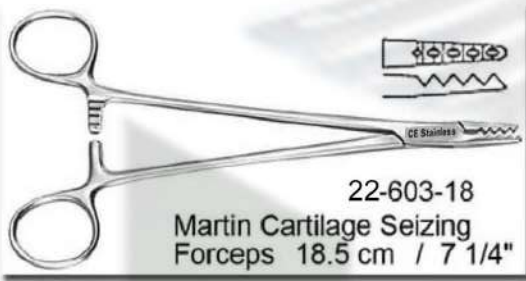

22-603-18
Martin Cartilage Seizing
Forceps 18.5 cm / 7 1/4"



22-604-18
Dingmann Cartilage Seizing
Forceps 18.5 cm / 7 1/4"

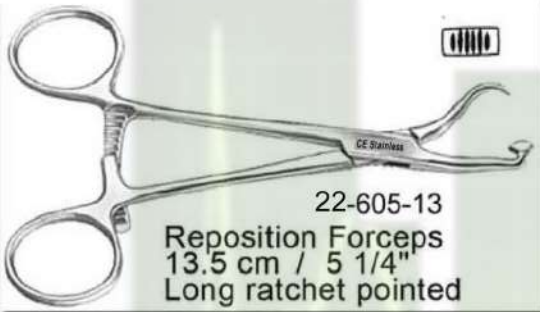

22-605-13
Reposition Forceps
13.5 cm / 5 1/4"
Long ratchet pointed

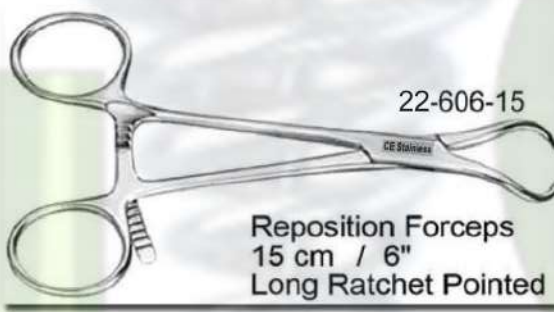

22-606-15
Reposition Forceps
15 cm / 6"
Long Ratchet Pointed

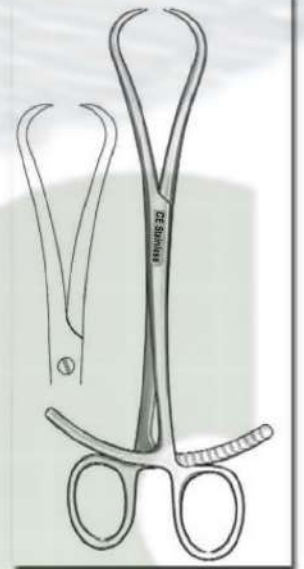

22-607-20
Walton Bone
Reduction Forceps
20.5 cm / 8"
2" Double Ratchet
Opening 9-100mm



22-608-17
Reill
Bone Reduction Forcep
17.5cm / 7"

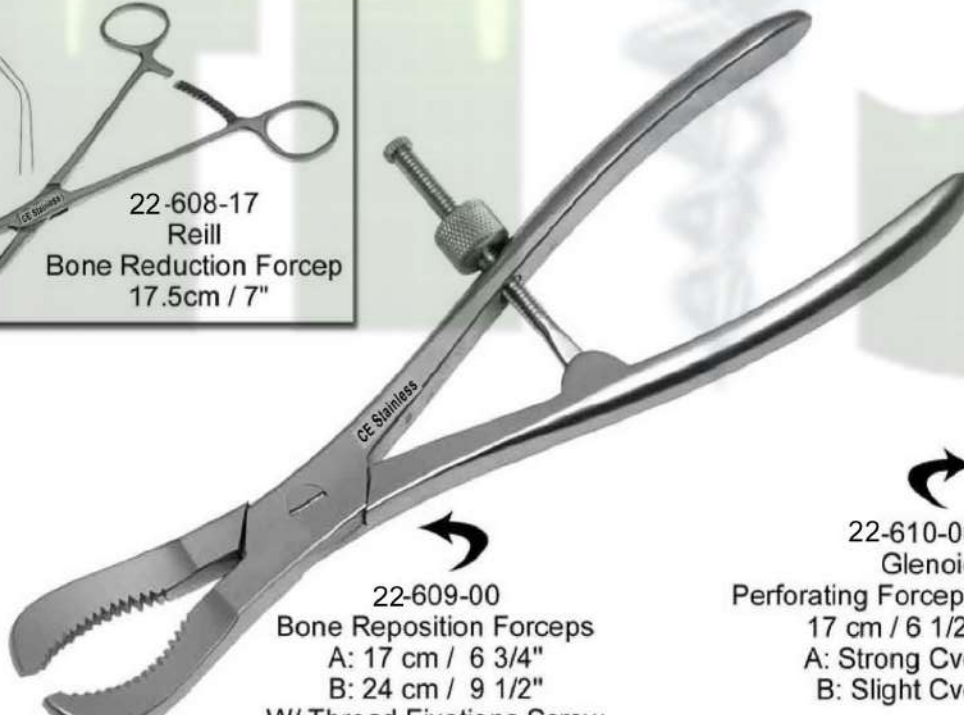

22-609-00
Bone Reposition Forceps
A: 17 cm / 6 3/4"
B: 24 cm / 9 1/2"
W/ Thread Fixation Screw

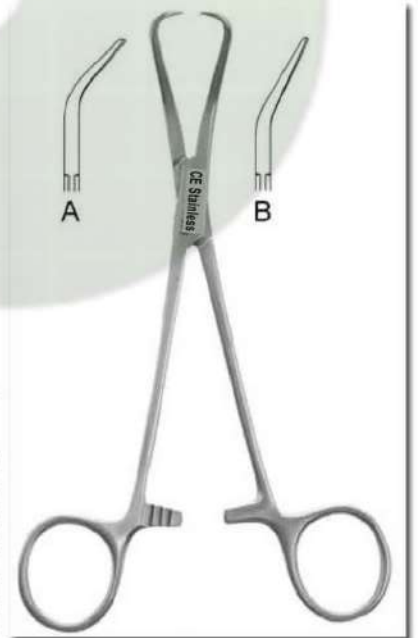

22-610-00
Glenoid
Perforating Forceps
17 cm / 6 1/2"
A: Strong Cvd
B: Slight Cvd

BONE CUTTING FORCEPS

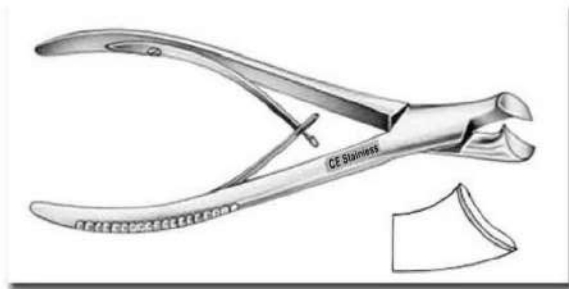

22-611-00
Marwalder Bone Nipper 18.5 cm / 7 1/4"

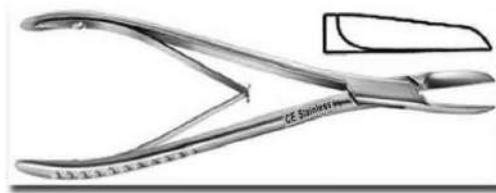

22-612-00
Cottle Kazanjian Bone Cutting Forceps
18.5 cm / 7 1/4"

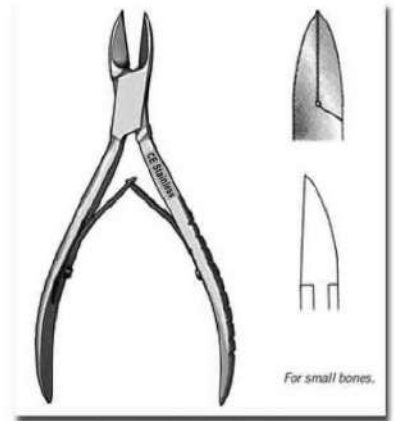

22-613-00
Littauer Bone Cutting Forceps
15 cm / 6"



22-614-00
Liston Bone Cutting Forceps



22-615-00
Cleveland Bone Cutting Forceps
A: 14.5 cm / 5 3/4"
B: 17 cm / 6 3/4"

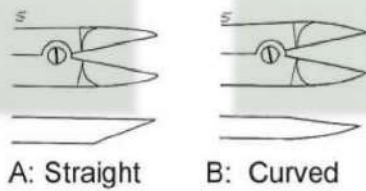
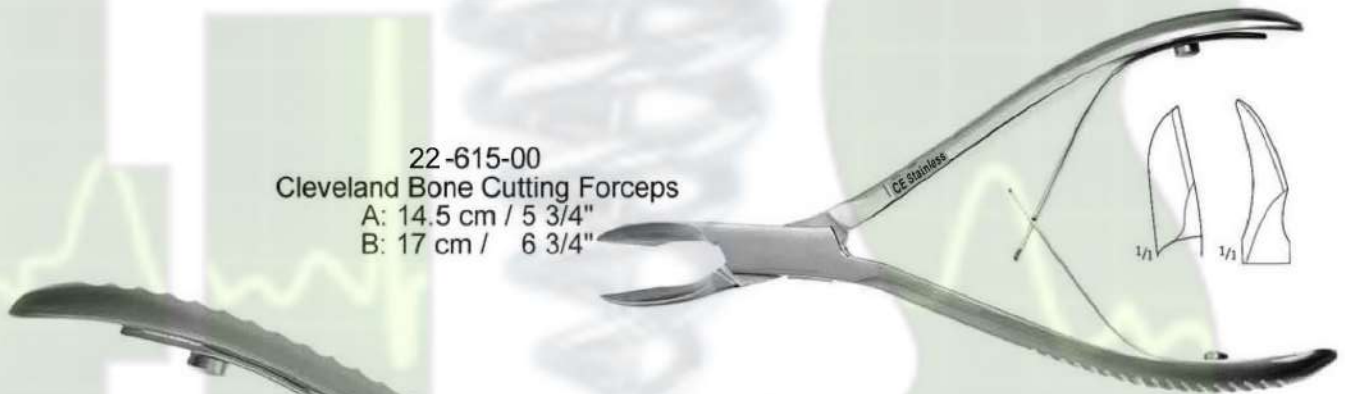

22-616-14
Kleinert-Kutz / Böhler Bone Cutting
Forceps 14.5 cm / 5 3/4"

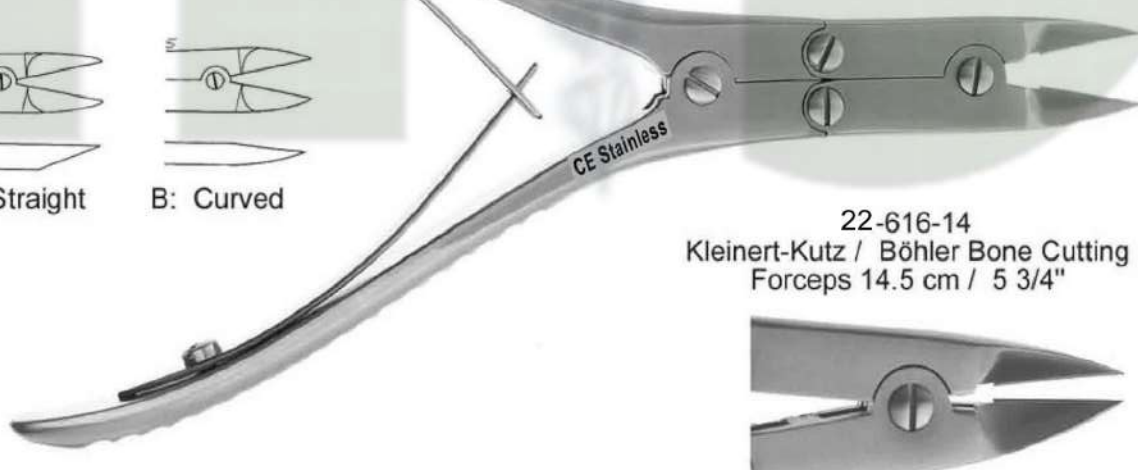



22-621-18
Mc Indoe
Bone Cutting Forceps
18 cm / 7"
Delicate Blades



22-622-25
Stille-Horsley / Liston Key
Bone Cutting Forceps
25.5 cm / 10"

45° Angled



90° Angled

Angled On Side

22-623-24
Semb
Bone Cutting Forceps
24.5 cm / 9 3/4"

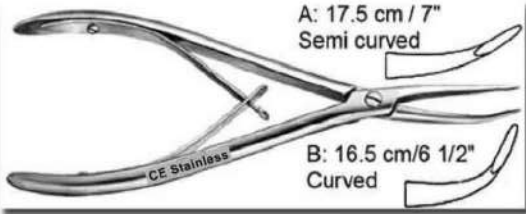

22-624-00 Stellbrink Bone Rongeur

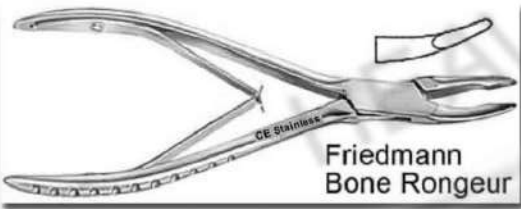

22-625-00 A: 12.5cm / 5"
B: 13.5cm / 5 1/4"



22-626-13 13.5 cm / 5 1/4"



22-627-00
A: 13.5 cm / 5 1/4" B 16.5 cm / 6 1/2"



22-628-16 Mead Bone Rongeur
16.5 cm / 6 1/2"

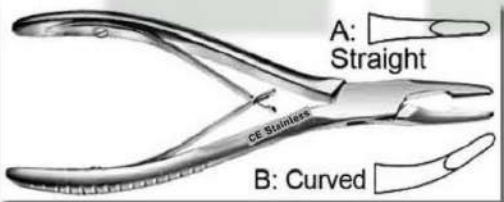

22-629-18 Jansen Bone Rongeur 18 cm / 7"



22-630-19 Lempert Bone Rongeur
19 cm / 7 1/2"

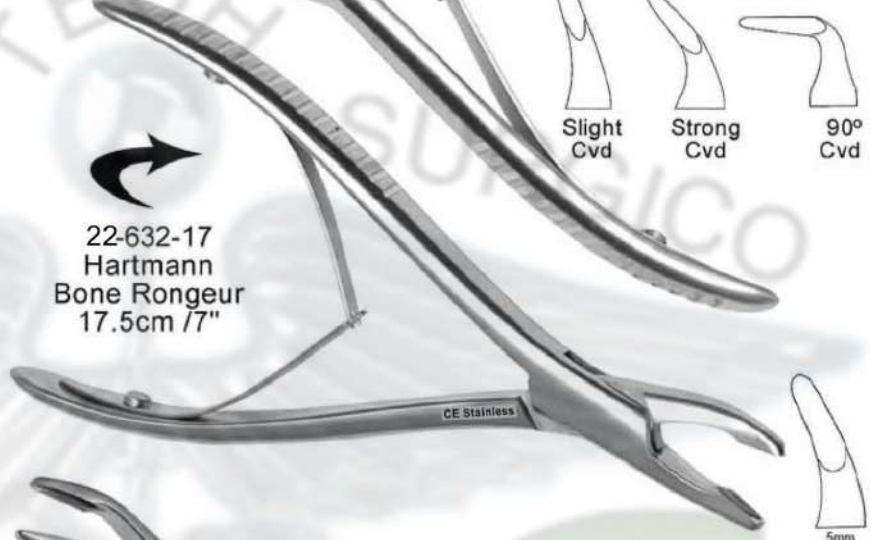

22-633-19 Jansen Bone Rongeur
19cm / 7 1/2"
Bayonet

22-634-00 Jansen Bone Rongeur
A: 14cm / 5 1/2"
B: 17cm / 6 1/2"
Straight

Screw Joint

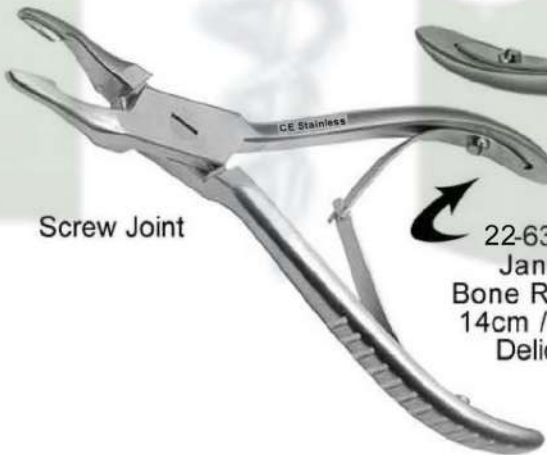

22-636-14 Luer Bone Rongeur

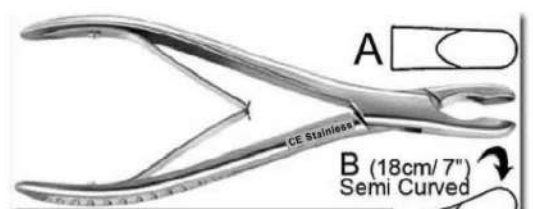

22-637-18 Luer Bone Rongeur

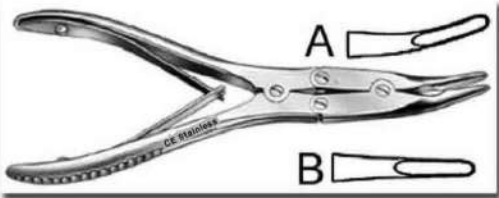

-638-15 Böhler Bone Rongeur
15.5 cm / 6"



22-639-18 Beyer Bone Rongeur
18 cm / 7"



22-640-18 Zaufal-Jansen
Bone Rongeur 18 cm / 7"



22-641-18
Mayfield Bone Rongeur
18 cm / 7"



22-642-20 Marquard
Bone Rongeur 20.5 cm / 8"



22-643-22
Stille Bone Rongeur
22.5 cm / 8 3/4"

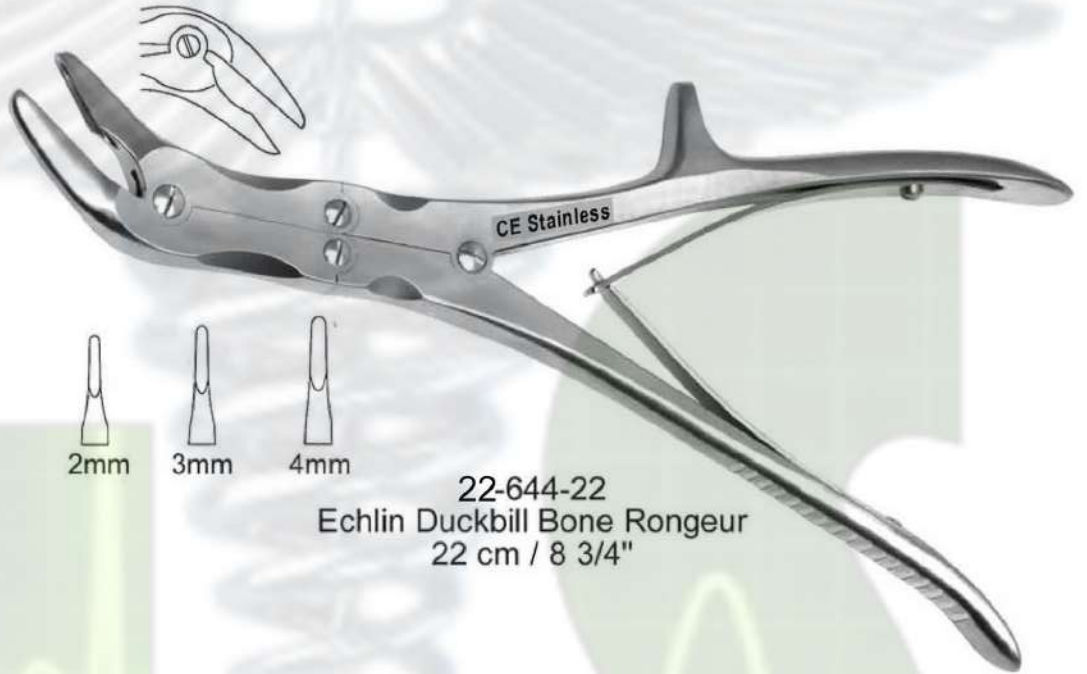

22-644-22
Echlin Duckbill Bone Rongeur
22 cm / 8 3/4"

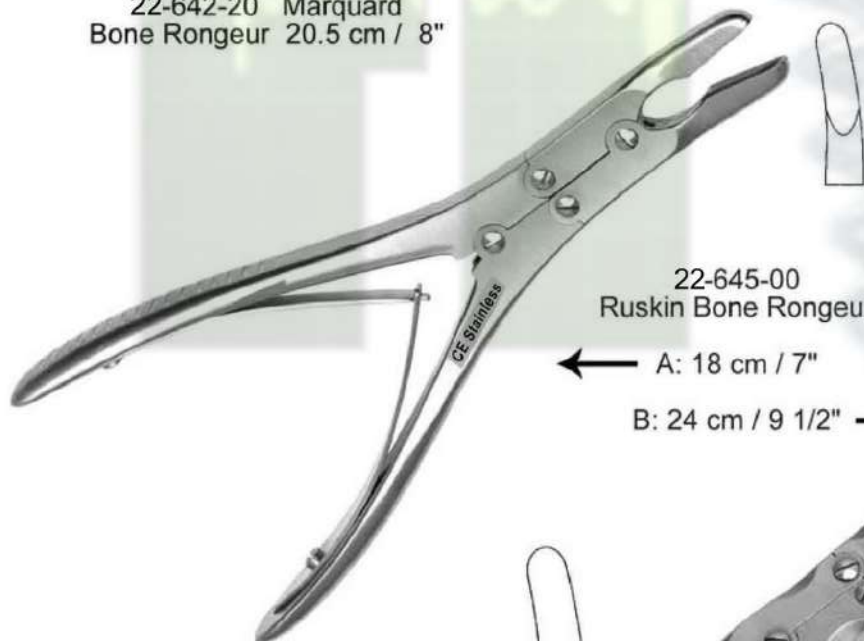
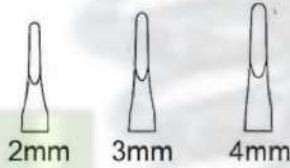

22-645-00
Ruskin Bone Rongeur

← A: 18 cm / 7"

B: 24 cm / 9 1/2" →



BONE RONGEURS - NIBBLERS



22-646-24
Leksell Stille
Bone Rongeur
24 cm / 9 1/2"

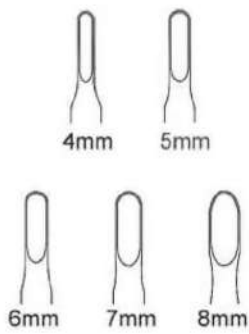

Same Size In Both Rongeurs



22-647-24
Leksell
Bone Rongeur
24 cm / 9 1/2"



22-648-24
Leksell Bone Rongeur
24 cm / 9 1/2"
4 / 5 / 6 / 7 / 8mm

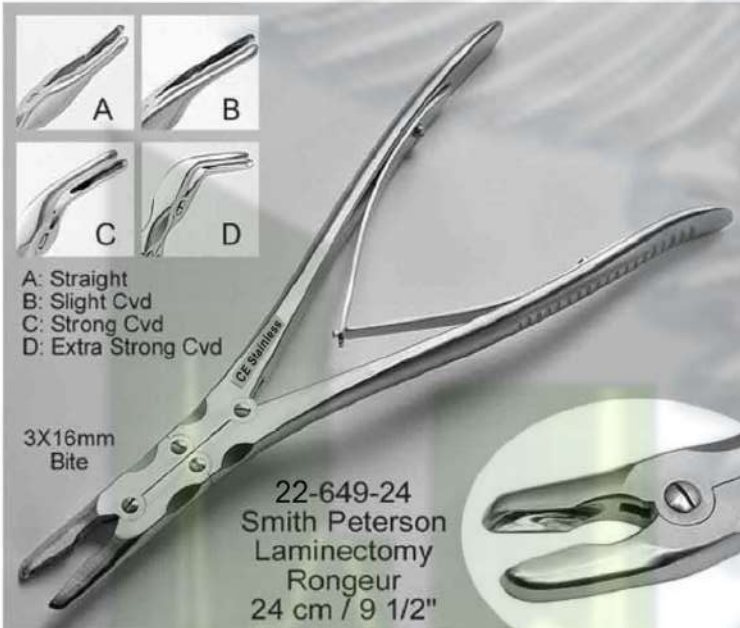

22-649-24
Smith Peterson
Laminectomy
Rongeur
24 cm / 9 1/2"

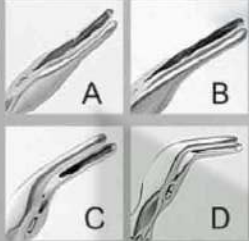

A: Straight
B: Slight Cvd
C: Strong Cvd
D: Extra Strong Cvd

3X16mm
Bite



22-650-23
Leksell Bone Rongeur
23 cm / 9"



22-651-15
Kleinert Kurtz
Synovectomy
Rongeur
15 cm / 6"



22-652-15
Kleinert Kurtz
Synovectomy
Rongeur
15 cm / 6"

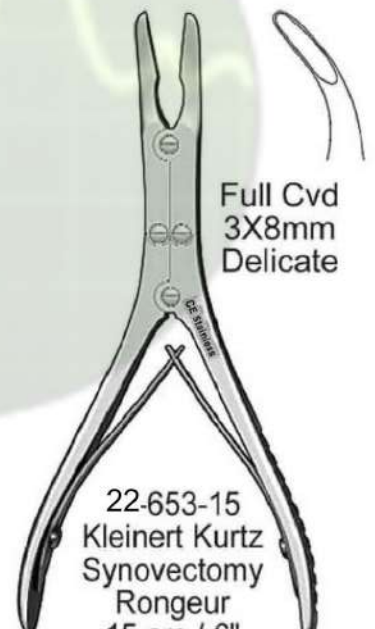
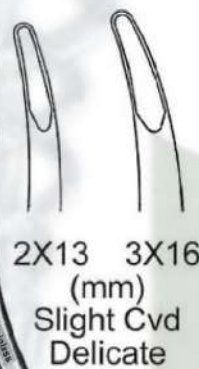

22-653-15
Kleinert Kurtz
Synovectomy
Rongeur
15 cm / 6"



Tooth
Inside



22-654-23
Semb Bone Rongeur
23.5 cm / 9 1/4"



CE Stainless

CE Stainless



8mm

22-655-23
Stille Ruskin
Bone Rongeur
23.5 cm / 9 1/4"

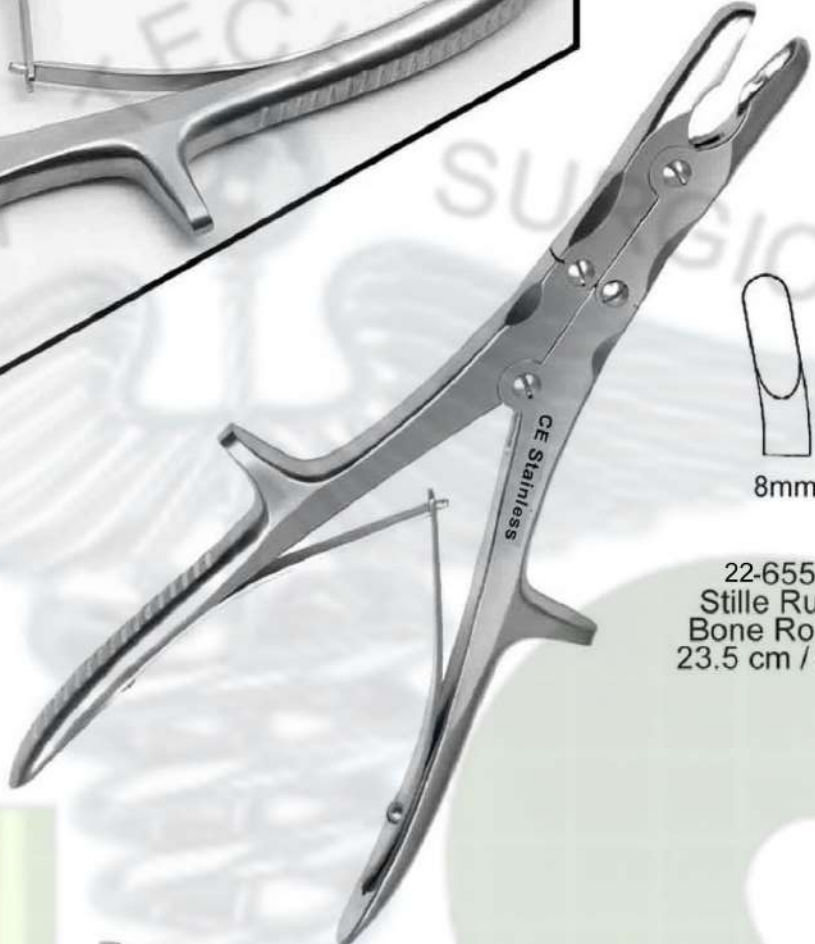

22-656-23
Stille Luer
Bone Rongeur
23 cm / 9"

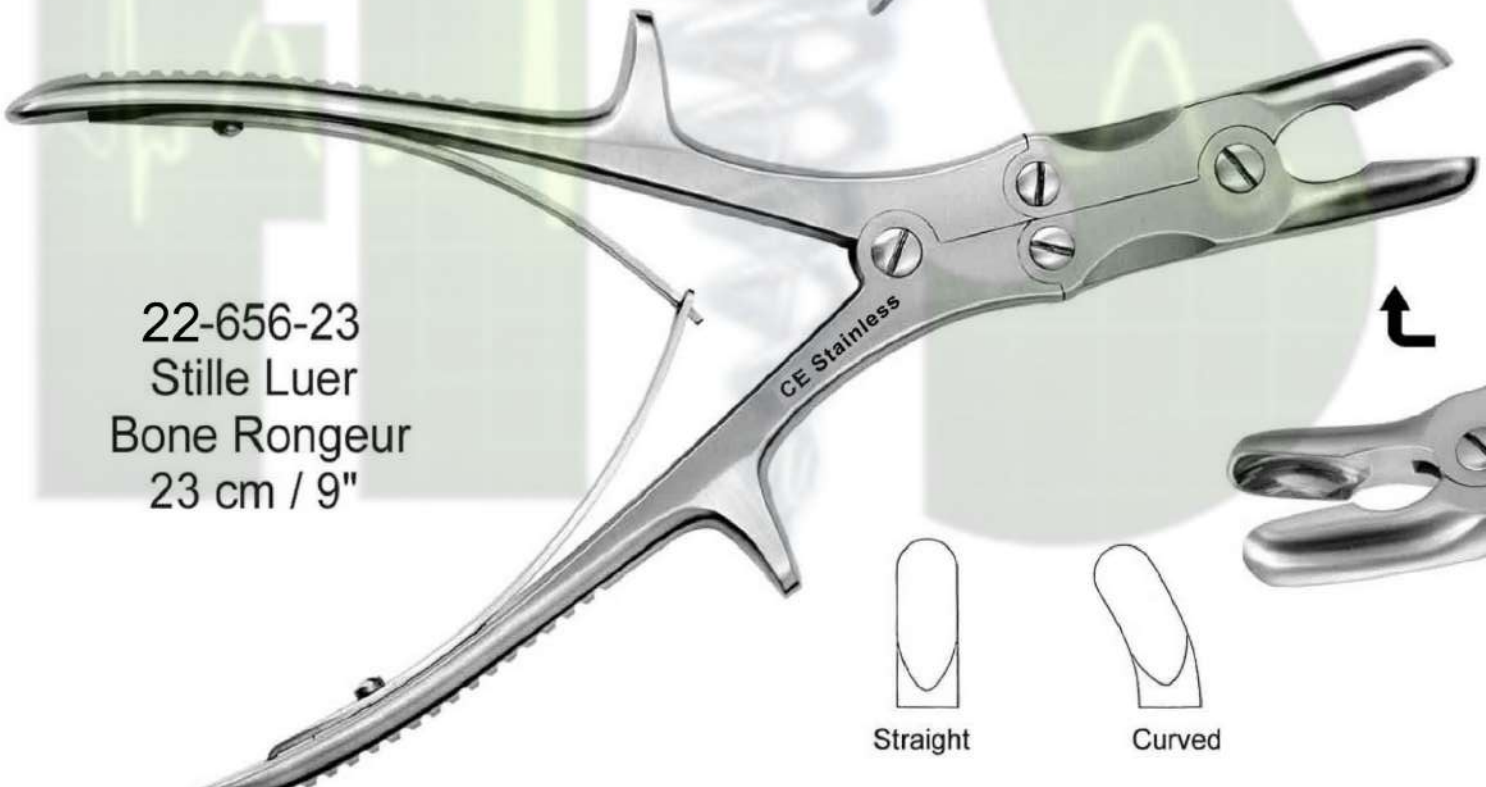

CE Stainless



Straight



Curved

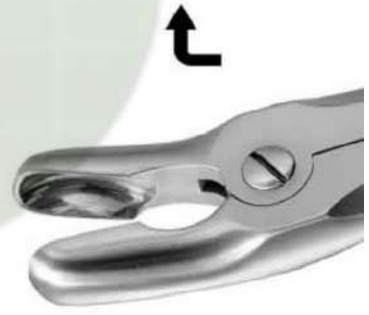



22-658-18
Mainz Long Neck Bone Rongeur 18 cm / 7"

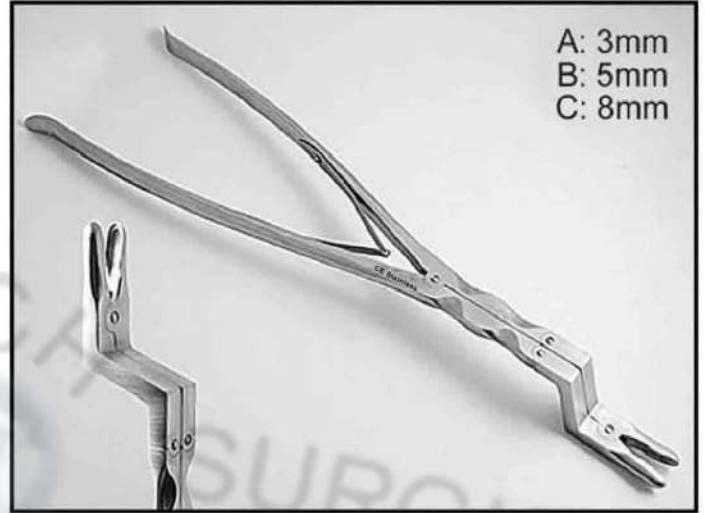

22-659-41
Leksell Bayonet Rongeur 41 cm / 16"

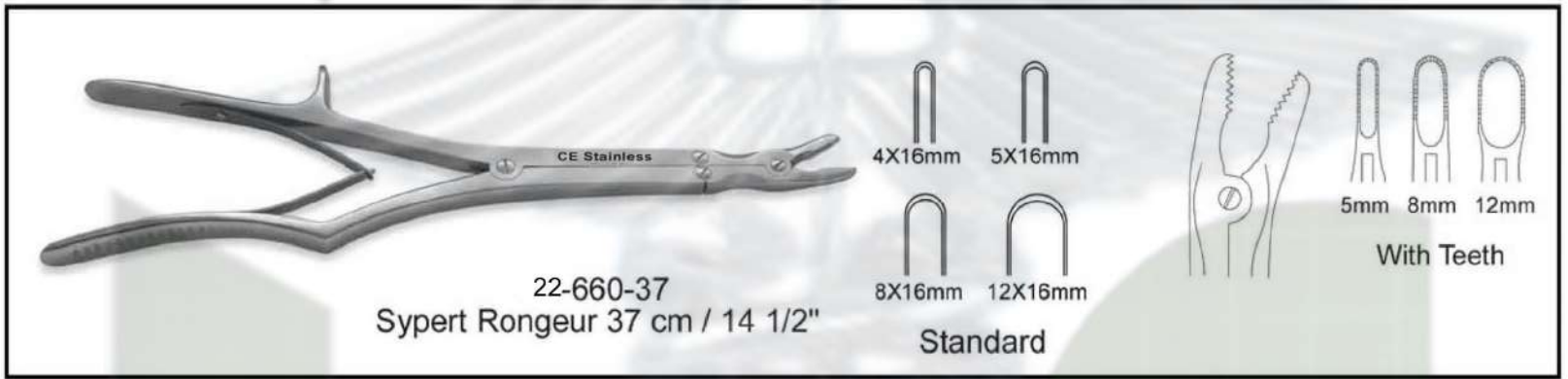

22-660-37
Sypert Rongeur 37 cm / 14 1/2"

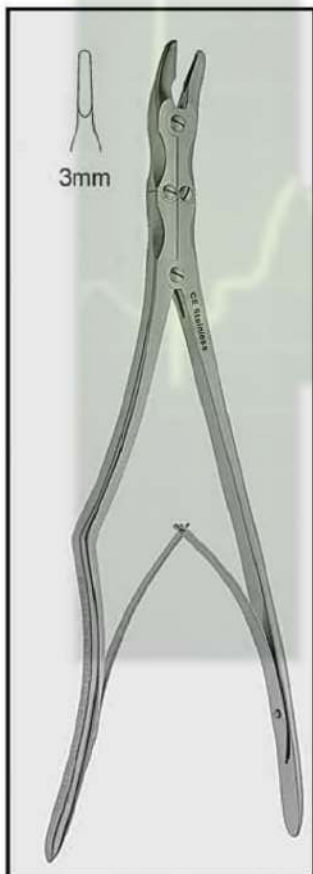

22-661-37
Dale Thoracic Rongeur 37 cm / 14 1/2"

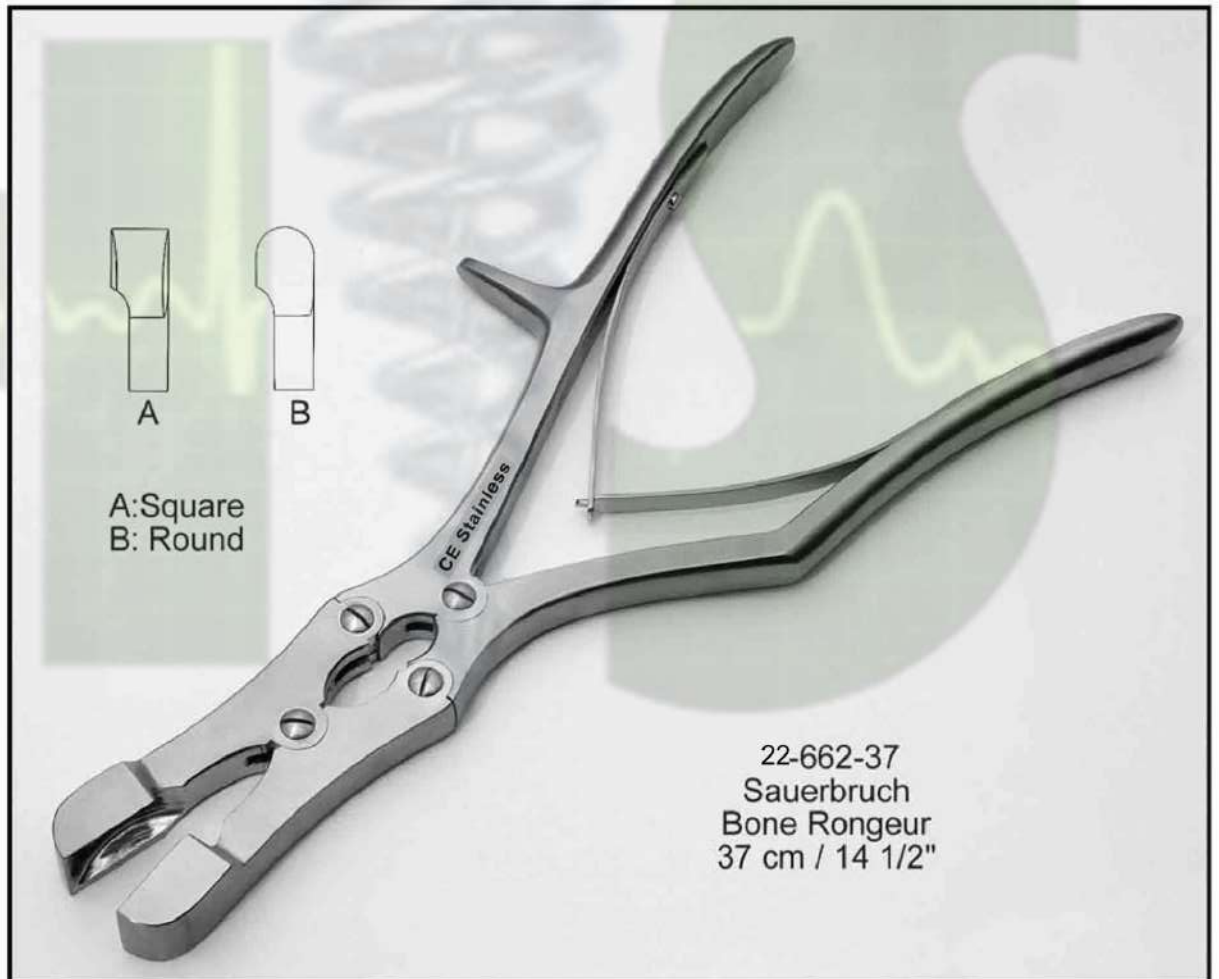

22-662-37
Sauerbruch Bone Rongeur 37 cm / 14 1/2"



30-663-22
Rib Shear
Double Spring
22 cm / 8 3/4"



22-664-00
Rib Shear
Double Spring
A: 20 cm / 8"
B: 23 cm / 9"



22-665-17
Collin Rib Shear
17.5 cm / 7"



22-666-17
Collin Rib Shear
17 cm / 6 3/4"



22-667-21
Stille Rib Shear
21 cm / 8 1/4"



22-668-00
Gluck
Rib Shear
A: 16 cm / 6"
B: 18 cm / 7"
C: 20 cm / 8"
D: 23 cm / 9"



Left

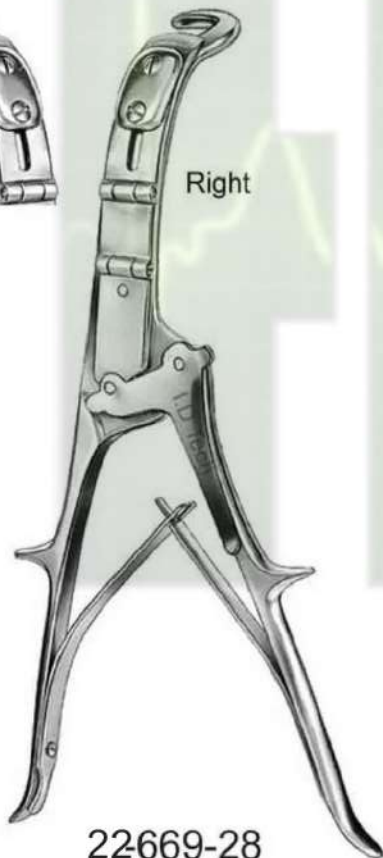

Right

22669-28
Brunner
Rib Shear
28 cm / 11"



22-670-25
Giertz Stille
Rib Shear
25 cm / 10"



22-671-00
Sauerbruch
Rib Shear
A: 23 cm / 9"
A: 26 cm / 10 1/4"



22-672-25
Labsche
Rib Shear
25 cm / 10"



22-673-24
T Handle Labsche Sternum Chisel
24 cm / 9 1/2"



22-674-17
Rib Shear
Sideward
17 cm / 6 3/4"



Pointed
Tips
22-208-34A
Bethune Rib Shear
S Shaped Handle
34 cm / 13 1/2"



22-675-34
Bethune Rib Shear
S Shaped Handle
34 cm / 13 1/2"



22-676-35
Coryllos-Bethune Rib Shear
S Shaped Handle
35 cm / 13 3/2"



Left

Right



22-677-33
Roos Rib Shear
Right Angled Jaw W/ Hook
25 cm / 10"

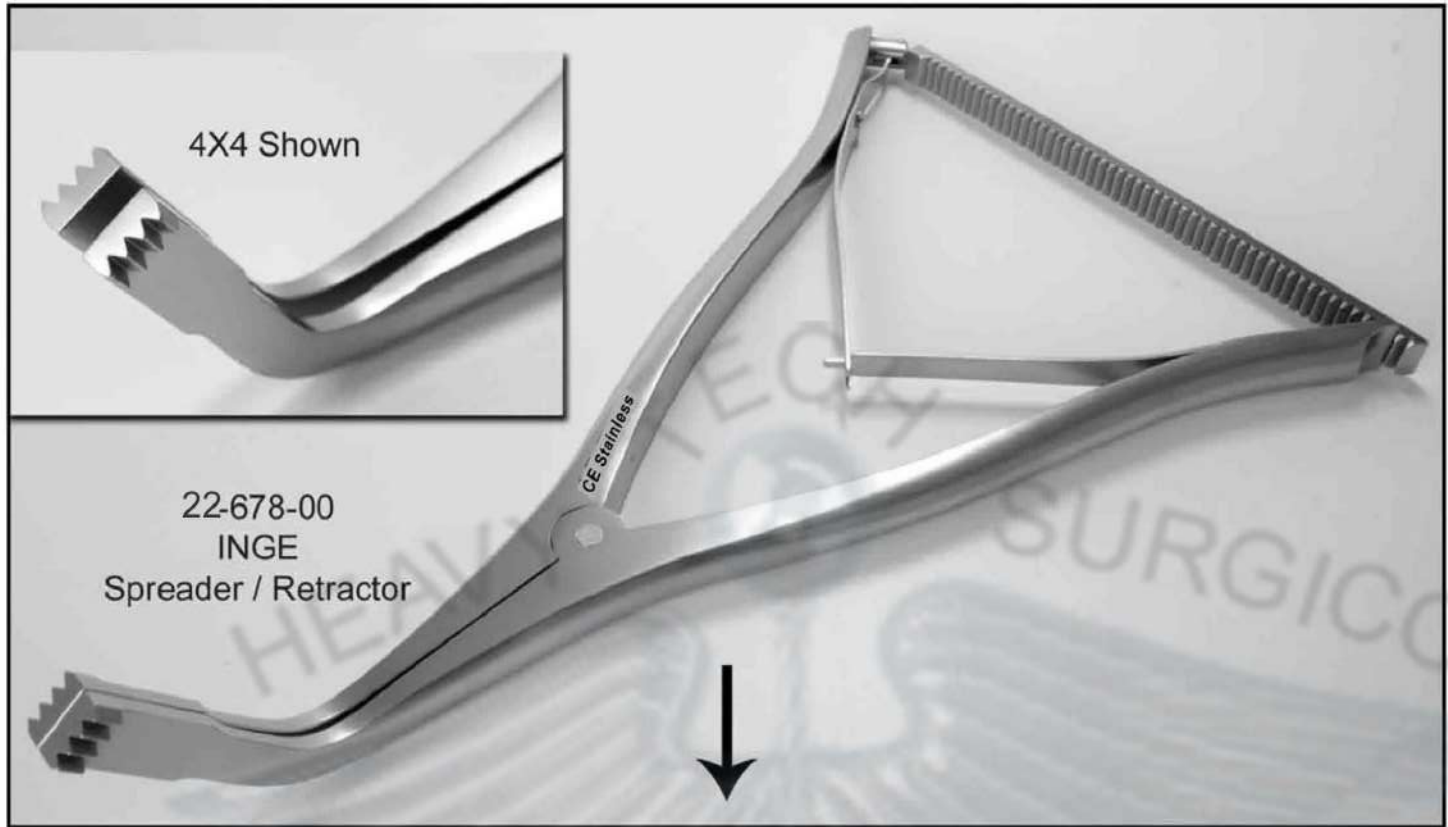

4X4 Shown

22-678-00
INGE
Spreader / Retractor

Available in 4X4 and 6X6 Teeth
and Without Teeth (Plain)

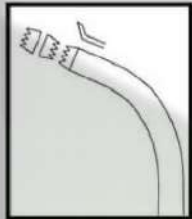

A: 4X4 Teeth
B: Without Teeth
16.5 cm / 6 1/2"

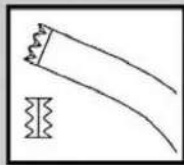

C: 4X4 Teeth
D: Without Teeth
25.5 cm / 10"

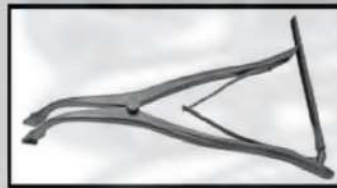

10 Inch Length Pattern

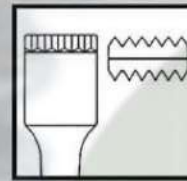

A: 6X6 Teeth
B: Without Teeth
27 cm / 10 1/2"
Flat Blades

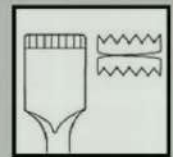

C: 6X6 Teeth
C: Without Teeth
27 cm / 10 1/2"
Concave Blades



22-679-25
Offset Lamina
Spreader / Retractor
25.5 cm / 10"

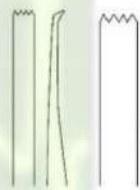

22-680-00
Vertibra
Spreader
/ Retractor
A: 18 cm / 7"
B: 28 cm / 11"



22-681-00
Inge Spreader
Serrated Outside
Blades
A: 18 cm / 7"

22-682-00
Saxsena Lamina
Spreader / Retractor
A: 18 cm / 7"
B: 25.5 cm / 10"
Serrated Outside
Blades





22-683-18
Calcaneal Spreader
Smooth Pads 15X12mm
18 cm / 7"



22-684-18
Calcaneal Spreader
Grooved Pads 15X12mm
18 cm / 7"

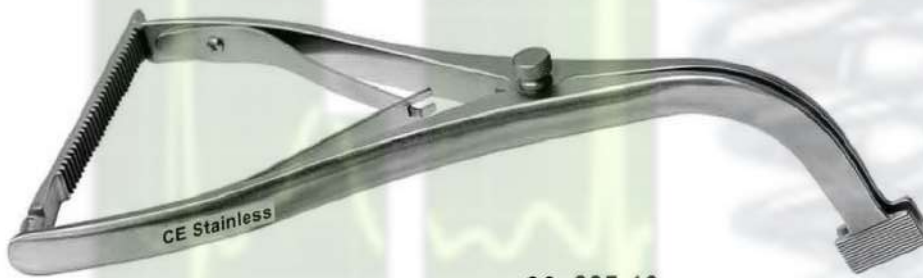

22-685-18
Lombardi Femoral
Tibial Spreader (Small)
A: Grooved Pads 22X13mm
18 cm / 7"



B: Damond Cut Pads 22X13mm



B: Damond Cut Pads 22X13mm



22-686-23
Lombardi Femoral
Tibial Spreader (Large)
A: Grooved Pads 22X13mm
23.5 cm / 9 1/4"



22-687-28
Compressing Forceps
28 cm / 11"
Adjustable Locking
For Screws and Rods



22-688-23
Distracting Forceps
23 cm / 9"
Long Ratchet / Spiral Pring
For Screws and Rods



22-689-25
Distracting Forceps
25.5 cm / 10"
Leaf Pring
For Screws and Rods



22-690-28
Compression Forceps
28 cm / 11"
Leaf Pring / Long Ratchet
For Screws and Rods



22-691-25
Distractor
25.5 cm / 10"
Leaf Pring
For Screws and Rods

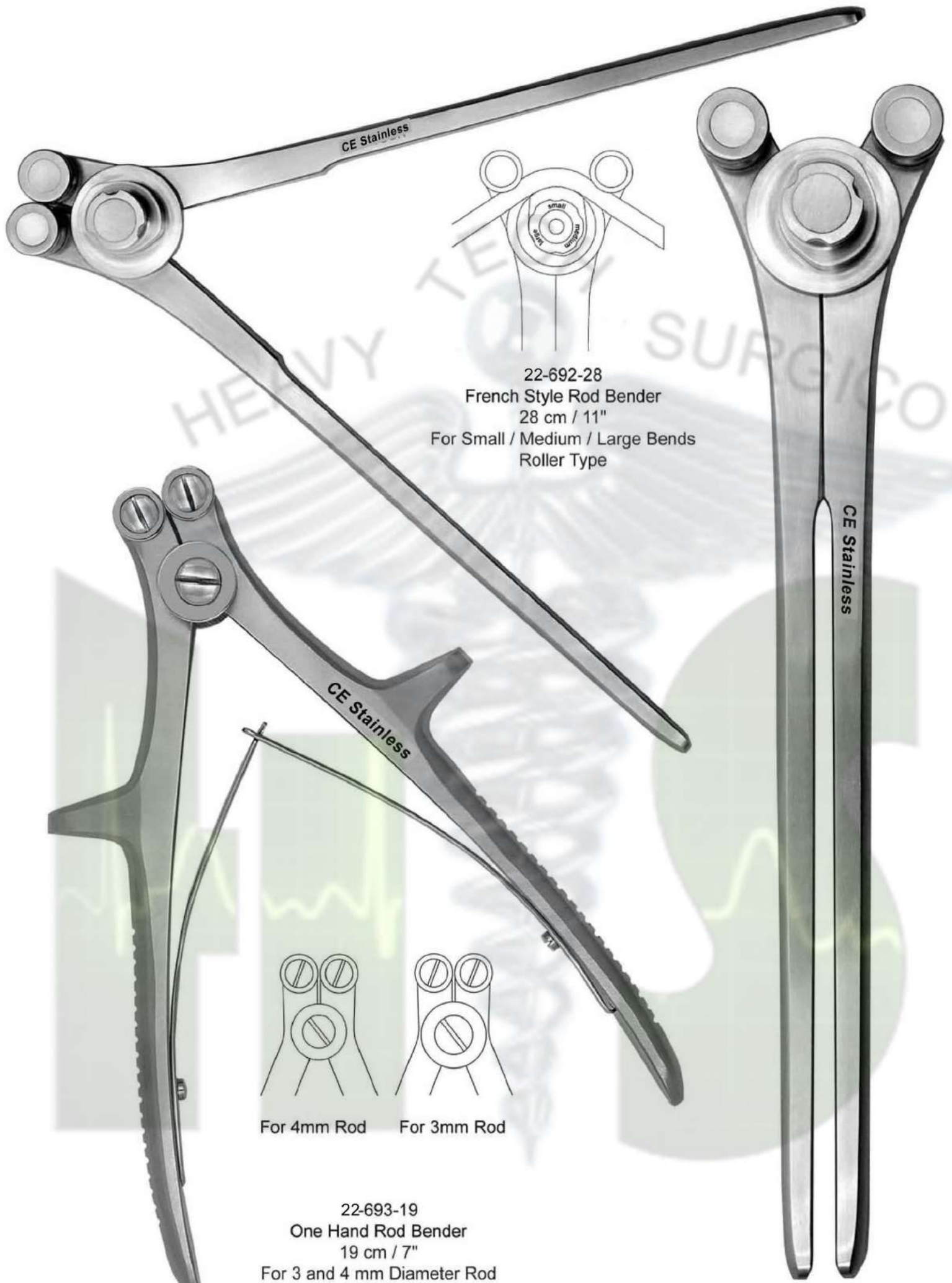

22-692-28
French Style Rod Bender
28 cm / 11"
For Small / Medium / Large Bends
Roller Type

For 4mm Rod For 3mm Rod

22-693-19
One Hand Rod Bender
19 cm / 7"
For 3 and 4 mm Diameter Rod

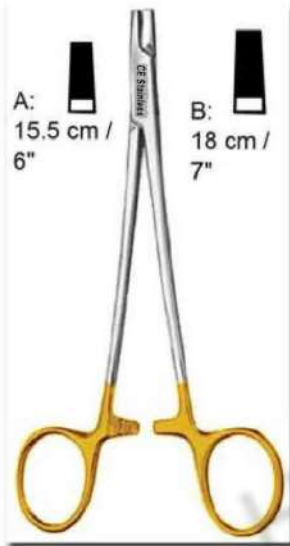

22-694-15-TC A / B
Wire Twisting
Forceps

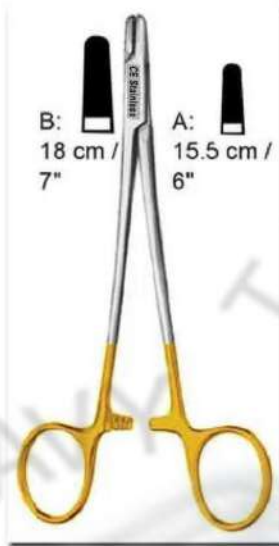

22-695-15-TC A / B
Wire Twisting
Forceps

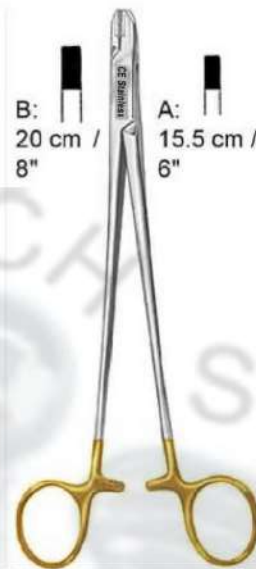

22-696-15-TC A / B
Wire Twisting
Forceps



22-697-18-TC Corwin
Combi-Wire Twisting
Forceps
18.5 cm / 7 1/4"



22-698-15-TC
Wire Twisting Forceps
15.5 cm / 6"



22-699-16-TC
Wire Twisting Forceps
16 cm / 6 1/4"



22-700-19-TC Wire Twisting
Forceps Heavy Pattern
19 cm / 7 1/2"

The Corwin-Hegar automatic Wire Twister is a special automatic twisting Instrument. In combination with a cerclage wire it can be used for fixation of fractures or temporal fixation. The Automatic Wire Twisters are available in different lengths and with various tungsten carbide inserts.



22-701-15-TC Corwin-Hegar
Auto Wire Twisting Forceps
15 cm / 6"



22-702-28-TC
Jet Wire Twisting Device

CARBIDE INSERTED SURGICAL SCISSORS

Scissors in this Section can also be Manufactured without Carbide Tips / Gold Plating

22-703-00-TC

Mayo

Scissors TC Gold

- A: 14.5 cm / 5 3/4" Str or Cvd
- B: 17 cm / 6 3/4" Str or Cvd
- C: 23 cm / 9" Str or Cvd

Blunt / Blunt



22-704-00-TC

Operating (Standard)
Scissors TC Gold

- A: 13 cm / 5" Str or Cvd
- B: 14 cm / 5 1/2" Str or Cvd
- C: 15.5 cm / 6 1/2" Str or Cvd
- D: 18 cm / 7" Str or Cvd



Sharp / Sharp
Cvd or Str



Blunt / Blunt
Cvd or Str



Sharp / Blunt
Cvd or Str

Please Mention Above Styles When Ordering Standard TC Scissors



22-705-00-TC

Mayo Stille

Scissors TC Gold

- A: 14.5 cm / 5 3/4" Str or Cvd
- B: 17 cm / 6 3/4" Str or Cvd
- C: 23 cm / 9" Str or Cvd

Blunt / Blunt



22-706-00-TC

Metzenbaum

Scissors TC Gold

- A: 14 cm / 5 1/2" Str or Cvd
- B: 17 cm / 6 3/4" Str or Cvd
- C: 20 cm / 8" Str or Cvd
- D: 23 cm / 9" Str or Cvd

Blunt / Blunt

Blunt / Blunt



22-707-00-TC

Mayo-Harrington

Scissors TC Gold

- A: 20 cm / 8" Str or Cvd
- B: 23 cm / 9" Str or Cvd
- C: 28 cm / 11" Str or Cvd
- D: 30 cm / 12" Str or Cvd

22-708-12-TC
Ortho Universal Scissors TC Gold
12 cm / 4 1/3"

22-709-16-TC
Mayo-Nobel
Scissors TC Gold
A: 16.5 cm / 6 1/2"



710-00-TC
Wire Cutting Plier TC Gold
A: 15 cm / 6" Cut Upto 1.3mm
B: 18 cm / 7" Cut Upto 1.6mm
C: 23 cm / 9" Cut Upto 2.5mm

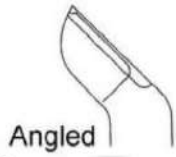

22-711-00-TC
Wire Cutting Plier TC Gold
A: 15 cm / 6" Cut Upto 1.3mm
B: 18 cm / 7" Cut Upto 1.6mm



22-712-23-TC
Wire Cutting Plier TC Gold
23 cm / 9" Cut Upto 2.5mm



22-713-18-TC
Wire Cutting Plier TC Gold
18 cm / 7" Cut Upto 1.6mm

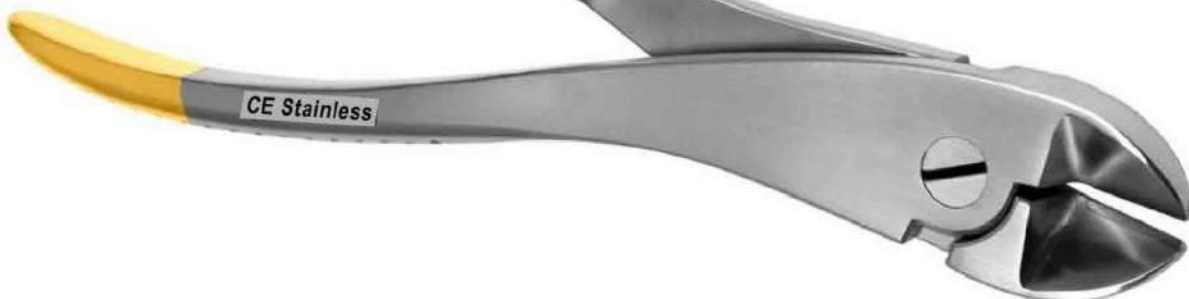

22-714-18-TC
Cannulated Pin Cutter TC Gold
18 cm / 7" Cut Upto 1.5mm



22-715-15-TC
Front End
Wire Cutting Plier
TC Gold
15 cm / 6"
Cut Upto 1.3mm



22-716-23-TC
Front End
Wire Cutting Plier
TC Gold
23 cm / 9"
Cut Upto 2.5mm



22-717-23-TC
Front End
Wire Cutting Plier
TC Gold
23 cm / 9"
Cut Upto 2.5mm

22-718-23-TC
Plate / Pin Cutting Plier
TC Gold
23 cm / 9"
Cut Upto 3.0mm



22-719-23-TC
Pin / Wire Cutting Plier
TC Gold / Adjustable
23 cm / 9"
Cut Upto 2.5mm



22-720-23-TC
Pin / Wire Cutting Plier
TC Gold
23 cm / 9"
Cut Upto 2.5mm



22-721-18-TC
Front / Side
Wire Cutting Plier
TC Gold
18 cm / 7"
Cut Upto 1.5mm



22-722-00-TC
Heavy Duty
Pin Cutting Plier
TC Gold

- A: 30 cm / 12" Cut Upto 3mm
- B: 47 cm / 18 1/2" Cut Upto 5mm
- C: 56 cm / 22" Cut Upto 6mm
- D: 60 cm / 24" Cut Upto 7mm

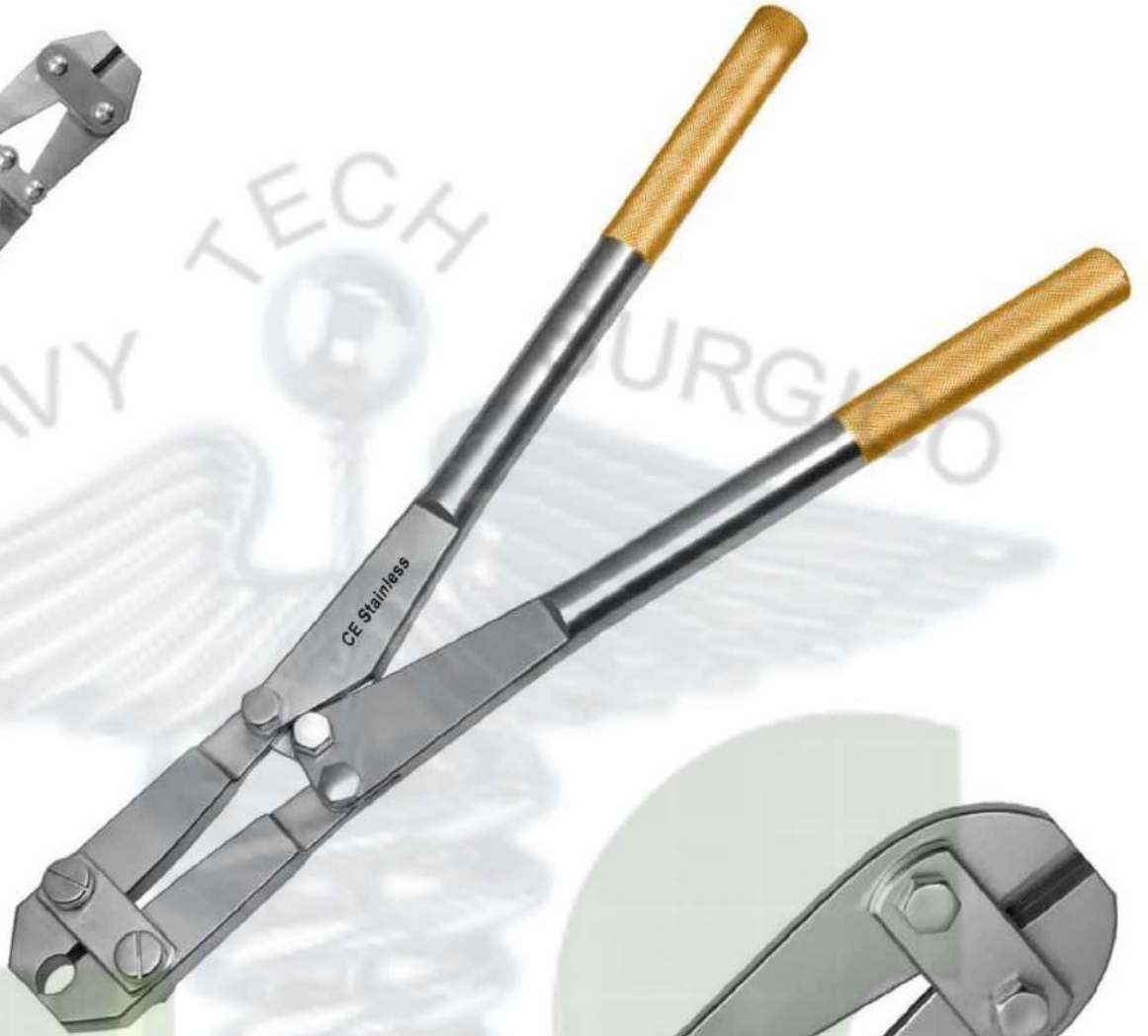

22-723-00-TC
Heavy Duty
Pin End Cutting Plier
TC Gold

- A: 27 cm / 10 1/2" Cut Upto 3mm
- B: 38 cm / 15" Cut Upto 4mm



22-724-00-TC
Heavy Duty
Rods / Steinmann Pin Cutting Plier
TC Gold / Adjustable / Locking System

- A: 30 cm / 12" Cut Upto 3mm
- B: 38 cm / 15" Cut Upto 4mm
- C: 47 cm / 18 1/2" Cut Upto 5mm
- D: 56 cm / 22" Cut Upto 6mm



Drill Bits for Quick Coupling

Drill bit 1.1mm dia.
for threaded hole for 1.5mm screws

Drill bit 1.5mm dia.
For threaded hole for 2.0mm screws and gliding hole for 1.5mm screws

Drill bit 2.0mm dia.
For threaded hole for 2.7 mm dia.
For gliding hole for 2.7mm screws

Item	Diameter	Total length	Usable length
310.110 ¹	1.1mm	060mm	035mm
310.150 ¹	1.5mm	085mm	060mm
310.160 ¹	1.5mm	110mm	085mm
310.190 ¹	2.0mm	100mm	145mm
310.120 ¹	2.0mm	125mm	100mm
310.210 ¹	2.7mm	100mm	075mm
310.280 ¹	2.7mm	125mm	100mm
310.260 ¹	2.7mm	100mm	075mm
310.280 ¹	2.0mm	125mm	100mm

Drill bit 2.5mm dia.
For threaded hole for 3.5 and 4.0mm screws

Drill bit 3.5mm
for gliding hole for 3.5mm screws

Item	Diameter	Total length	Usable length
310.250 ¹	2.5mm	110mm	085mm
310.230 ¹	2.5mm	180mm	155mm
310.350 ¹	3.5mm	100mm	085mm
310.370 ¹	3.5mm	195mm	170mm

Drill bit 3.2mm dia.
For threaded hole for 4.5 and 6.5mm screws

Drill bit 4mm dia.
For gliding hole for 4.5mm screws

Item	Diameter	Total length	Usable length
310.190 ¹	2.0mm	100mm	145mm
310.020 ¹	3.2mm	225mm	200mm
310.310 ¹	3.2mm	145mm	120mm
310.290 ¹	3.2mm	195mm	170mm
310.440 ¹	4.5mm	145mm	120mm
310.480 ¹	4.5mm	195mm	170mm

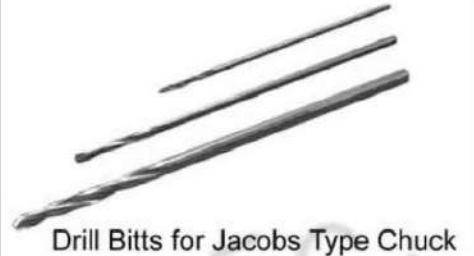

Drill Bits for Jacobs Type Chuck

Drill Bit for Jacobs chuck

Item	Diameter	Total length	Usable length
310.100	1.1mm	45mm	30mm
310.140	1.5mm	70mm	55mm
310.200	2.0mm	85mm	70mm
310.240	2.5mm	095mm	080mm
310.270	2.7mm	85mm	70mm
310.320	3.2mm	130mm	115mm
310.300	3.2mm	180mm	165mm
310.360	3.5mm	095mm	080mm
310.380	3.5mm	180mm	165mm
310.450	4.5mm	130mm	115mm
310.490	4.5mm	180mm	165mm



Tap for 2.0mm Cortex Screws
Predrilling: 1.5mm dia.

Item	Thread length	Total length
311.190 ¹	24mm	053mm
311.210	38mm	100mm

Tap for 2.7mm Cortex Screws
Predrilling: 2.0mm dia.

Item	Thread length	Total length
311.260 ¹	33mm	100mm
311.280	40mm	150mm

311.280¹
Tap for 2.7mm Cortex Screws
total length 125mm, thread length 40mm
predrilling: 2.0mm dia.



311.150¹
Tap for 1.5mm Cortex Screws
total length 50mm, thread length 20mm
predrilling: 1.1mm dia.

311.660¹
Tap for 6.5mm Cancellous Bone Screws
length 195mm, predrilling: 3.2mm dia.

Tap for 4.0mm Cancellous Bone Screws

Item	Total length	Usable length
311.340 ¹	110mm	085mm

311.690¹
Tap. Cannulated, for 7.0mm Cannulated Screws
length 230mm

Predrilling: 3.2mm

Item	Length	Type
311.460 ¹	125mm	thread length 70mm
311.470	175mm	with length markings

311.320
Tap for 3.5mm Cortex Screws
total length 110mm, thread length 50mm
predrilling: 2.5mm dia.

Tap for 3.5mm Cortex Screws
Predrilling: 2.5mm dia.

Item	Total length	Type
311.310	175mm	with length markings
311.320 ¹	110mm	thread length 50mm

311.460¹
Tap for 4.5mm Cortex Screws
total length 125mm, thread length 70mm
predrilling: 3.2mm dia.

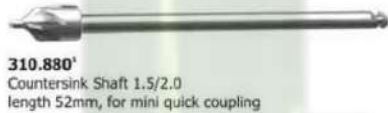

310.880¹
Countersink Shaft 1.5/2.0
length 52mm, for mini quick coupling

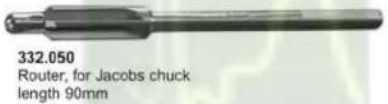

332.050
Router, for Jacobs chuck
length 90mm

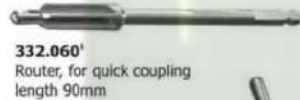

332.060¹
Router, for quick coupling
length 90mm

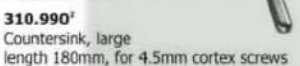

310.990¹
Countersink, large
length 180mm, for 4.5mm cortex screws



310.890¹
Countersink Shaft 3.5mm
length 72mm, for quick coupling,
to countersink the screw head



310.790
Countersink, cannulated, for 7.0mm Cannulated Screws
length 230mm



310.950¹
Handle with mini quick coupling



392.040
Hand Chuck for Kirschner Wires
length 145mm. Spanner with 0.6 to 1.6mm dia



311.430¹
Handle with quick coupling
length 110mm
for countersinks and
instruments for the removal of damaged screws



311.440¹
T-Handle with quick coupling
length 80mm, for taps



311.011
Handle, small, with mini quick coupling



311.012
Handle, medium, with mini quick coupling



311.013
Handle, large, with mini quick coupling



314.140
Allen Key, hexagonal, angled
for 4.5 to 7.0mm screws



314.160
Allen Key, hexagonal, small, angled



314.030¹
Screwdriver Shaft, hexagonal, small
length 100mm, for quick coupling
For 2.7 to 4.0mm screws.



314.320¹
Screwdriver Shaft, hexagonal, with Holding Sleeve
for 1.5 and 2.0mm stainless steel screws
with hexagonal socket,



314.130
Screwdriver, hexagonal, with T-Handle,
large to loosen tight screws.
A normal screwdriver can be
additionally inserted in the hollow
shaft of the T-handle.



314.170
Screwdriver with Universal Joint, large
length 290mm



314.300
Screwdriver, hexagonal, with Holding Sleeve,
length 165mm for 1.5 and 2.0mm stainless
steel screws with hexagonal socket



314.060
Holding Sleeve



314.060¹
Holding Sleeve for no. 314.030
single, as spare



314.150¹
Screwdriver Shaft, Hexagonal, large
length 100mm,
Final tightening of the screw has to
be done by hand.



314.670¹
Screwdriver Shaft, cruciform, 1.5/2.0, with Holding Sleeve
length 50mm, for 1.5 and 2.0mm



314.070¹
Screwdriver, hexagonal, small with groove
length 200mm, for 2.7 to 4.0mm screws



314.270¹
Screwdriver, hexagonal, large, with groove
length 240mm



314.020¹
Screwdriver, hexagonal, small, with Holding Sleeve
length 200mm



313.980
Holding Sleeve for Mini Screws



312.300¹
Insert Drill Sleeve 3.5/2.5
length 42mm, drill bit 2.5mm dia.



312.480¹
Insert Drill Sleeve 4.5/3.2
length 80mm
for long lag screws



319.310¹
Trocar 2.0mm dia.
Length 118mm, for percutaneous insertion of 7.0mm cannulated screws



319.320¹
Drill Sleeve 4.5/2.0
length 109mm, for percutaneous insertion of 7.0mm cannulated screws



319.330¹
Drill Sleeve 8.0/4.5
length 100mm, for percutaneous insertion of 7.0mm cannulated screws



322.260¹
Handle for Drill Guides
single



397.300¹
Drill Sleeve 3.0 with point
length 55mm



322.260
Handle for Drill Guides
for nos. 397.150 to 170. single



Item	For diameter
397.150	1.5mm
397.160	2.0/2.7mm



397.170
Drill Sleeve 2.7



312.140¹
Double Drill Sleeve 1.5/1.0
for 1.5mm cortex screws
drill bits, 1.5 and 1.1mm dia



312.220¹
Double Drill Sleeve 2.0/1.5
for 2.0mm cortex screws



312.240¹
Double Drill Sleeve 2.7/2.0
for 2.7mm cortex screws



312.280¹
Double Drill Sleeve 3.5/2.5
for 3.5mm cortex screws and 4.0mm cancellous bone screws
drill bits 3.5 and 2.5 dia.,



312.460¹
Double Drill Sleeve 4.5/3.2
for 4.5mm cortex screws
drill bits: 4.5 and 3.2mm dia



312.670¹
Double Drill Sleeve 6.5/3.2
for 6.5mm cancellous bone screws
drill bit: 3.2mm dia.



323.260
Universal Drill Sleeve 2.7
Drill bits 2.0 and 2.7mm dia.,
Suitable for LC-DCP and round hole plates.



323.360
Drill Guide 3.5
Drill bit 2.5 and 3.5mm dia., And tissue protection for taps nos.
311.310/320/340, Suitable for LC-DCP and round hole plates.



323.460¹
Universal Drill Guide 4.5/3.2
Drill bits 3.2 and 4.5mm dia.

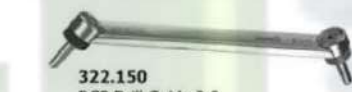

322.150
DCP Drill Guide 2.0
for neutral and load position
drill bit 1.5mm dia.

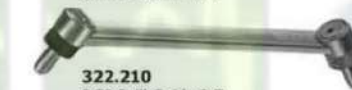

322.210
DCP Drill Guide 2.7
for neutral and load position
drill bit 2.0mm dia.



322.320¹
DCP Drill Guide 3.5
for neutral an load position, drill bit 2.5m dia.



322.440¹
DCP Drill Guide 4.5
for neutral and load position, drill bit 3.2mm dia.



323.350¹
LC-DCP Drill Guide 3.5
for neutral an load position, drill bit 2.5mm dia.



323.450¹
LC-DCP Drill Guide 4.5
for neutral and load position, drill bit 3.2mm dia.



322.430¹
DCP Hip Drill Guide 4.5
for neutral and load position, for 4.5mm screws with DHS and angled blade plates, sleeve length 60mm, drill bit 3.2mm dia.



312.200¹
Triple Drill Sleeve 2.0
with 3 holes, opposite side 1 hole



322.240¹
DCP Mandible Drill Guide 2.7 short
drill bit 2.0mm dia



322.250¹
DCP Mandible Drill Guide 2.7 long
drill bit 2.0mm dia



312.330
Insert Drill Sleeve with stop, for 4.5mm screws adjustable length to limit drilling depth, external dia. 4.5mm for drill bits of 3.2mm dia.

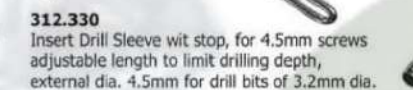

319.340¹
Protection Sleeve 11.0/8.0
for percutaneous insertion of 7.0mm cannulated screws



319.300¹
Parallel drill Guide 4.5
for percutaneous insertion of 7.0mm cannulated screws



312.710¹
Parallel Wire Guide 2.0mm dia.



319.010²
Depth Gauge for 2.7 to 4.0m screws
measuring range up to 60mm



319.010¹
Depth Gauge for 2.7 to 4.0mm screws
measuring range up to 60mm



319.100¹
Depth Gauge for 4.5mm to 6.5mm screws
measuring range up to 110mm



332.010¹
Triple Drill Guide
130° angle, for 130° angled blade plates and for condylar plates,
drill bit 4.5mm dia.



312.850
Drill Guide with stop 3.5/2.7
to limit drilling depth



314.090¹
Holding Sleeve
length 80mm, for 2.7 to 4.0mm screws

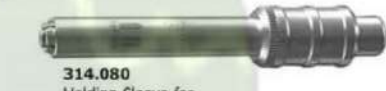

314.080
Holding Sleeve for
length 80mm for 2.7mm screws and
3.5mm cannulated screws



314.280¹
Holding Sleeve, large, length 120mm
for Nos. 314.190/240/260/270/275



319.970¹
Screw Forceps, self-holding
length 85mm, to take screws out of the screw racks



Bending Iron for plates 2.7 and 3.5
Length 150mm, slid widths 2.5 and 4.5mm, required paris
Item Slid placement
329.040¹ 4.5/2.5mm
329.050¹ 2.5/4.5mm



312.470
Drill Sleeve, pointed



Bending Iron for plates 1.5 and 2.0
Item Length Slid width



329.020
Bending Iron LC-DCP/DCP
length 250mm, for small and broad LC-DCP, DCP
slit widths 5 and 7mm Required in pairs



392.000¹
Bending Iron for Kirschner Wires
length 120mm, for 1.25 to 2.5mm dia.



392.020
Bending Iron for Kirschner Wires
length 115mm, for 0.8 to 1.25mm dia.



329.080
Bending Iron for Reconstruction Plates 3,5 and 4.5
length 190mm, required in paris



397.110
Handle with Sleeve
with rotating drill guide and anchoring point



397.120
Trocar Point, large, for number 397.110
for nos. 387.000/397.110



397.130
Cheek Retractor Ring, for number 397.110
for nos. 387.000/397.110



321.160¹
Combination Wrench 11mm
length 140mm



321.170¹
Pin Wrench
length 120mm, 4.5mm dia.
For tension device, distractor and knurled
nut of insertion handle for intramedullary nail



321.150¹
Socket Wrench 11mm
length 200mm



332.200¹
Slotted Hammer
length 270mm



332.160¹
Inserter/Extractor, with Adjustable Clamps
length 270mm, for the insertion and extraction of angled plates for
adults and hip plates for adolescents and children as well as tibial
plateau osteotomy plates.



332.350
Inserter/Extractor
length 175mm, for infant hip plate and mini hip plate.



329.290
Bending Pliers for Reconstruction Plates 2.7 and 3.5
length 240mm



329.150¹
Bending Pliers for plate 2.4 to 4.0
length 230mm



329.240
Bending Pliers for plates



329.250
Anvil, narrow



329.260
Anvil, large



329.300
Bending Press
length 400mm



391.950¹
Cutter for thin plates 1.5 to 2.7
length 256mm



329.270¹
Bending Pliers
for reconstruction plates 2.7,
length 270mm, required in paris



391.230¹
Cerclage Wire Tightener
length 260mm
for twisting, for temporary fixation during reduction



321.120¹
Tension Device, articulated
Span 20mm, can also be used as a distractor.
Colour scale: yellow up to 500N, green up to 1000N,
red above 1000N.



332.090¹
Chisel Guide
with adjustable angle



399.010
Forceps with Sliding Blades
complete with two interchangeable blades
length 155mm, weight 42 g, speed lock



399.020
Blade with foot
single



399.030
Blade with tip
single



319.020
Measuring Device
for drill bits, screws, Kirschner wires, and Steinmann pins



319.440¹
Holding Clip



391.100²
Wire Passer
45mm bending diameter



391.130¹
Wire Passer
70mm bending diameter



391.210²
Wire Tightener
length 240mm. with handle and two deas



397.700¹
Handle with quick coupling
length 150mm

397.750¹
Cancellous Bone Impactor, rectangular,
10x20mm Length 140mm

397.860¹
Gouge, curved, 10mm wide
length 140mm

397.830
Gouge, straight, 15mm wide
length 140mm

397.710¹
Cancellous Bone Impactor, curved, 6mm dia.
Length 140mm

397.760¹
Cancellous Bone Impactor,
rectangular, 10x30mm
Length 140mm

397.790
Rasp, round
Length 140mm

397.870¹
Gouge, curved, 15mm wide
length 140mm

397.910¹
Gouge, flat, straight, 16mm wide
length 140mm

397.720¹
Cancellous Bone Impactor, curved, 6mm dia. flattened
Length 140mm

397.800
Rasp, half-round
length 140mm

397.930
Chisel, flat, curved, 16mm wide
length 140mm

397.960
Chisel, flat, curved, 4mm wide
length 140mm

397.730¹
Cancellous Bone Impactor, straight, 8mm dia.
Length 140mm

397.810
Gouge, straight, 5mm wide
length 140mm

397.970
Chisel, flat, curved, 8mm wide
length 140mm

397.990
Chisel, flat, curved, 20mm wide
length 140mm

397.740¹
Cancellous Bone Impactor, rectangular, 6x16mm
Length 140mm

397.850
Gouge, curved, 5mm wide
length 140mm

397.820
Gouge, straight, 10mm wide
length 140mm

Cerdag Wire with eye			Cerdag Wires without eye		
Item	Diameter	Length	Item	Diameter	Length
291.080	0.80mm	280mm	291.220	0.40mm	150mm
291.010 ¹	1.00mm	280mm	291.240	0.60mm	175mm
291.020 ¹	1.25mm	280mm	291.260	0.80mm	200mm
291.030	1.00mm	600mm	291.270	1.00mm	250mm
291.040	1.25mm	600mm	291.280	1.25mm	300mm
291.110	1.50mm	280mm			
291.120	1.50mm	600mm			

- Diameter Ø
- A: 0.2 mm
 - B: 0.3 mm
 - C: 0.4 mm
 - D: 0.5 mm
 - E: 0.6 mm
 - F: 0.7 mm
 - G: 0.8 mm
 - H: 0.9 mm
 - I: 1.0 mm
 - J: 1.2 mm
 - K: 1.5 mm



25-100-00
Bone Wire Soft
Coil of 10 Meters
Implantable Material

Shanz Screws
Implantable Material

2 x 60 x 15 mm	5 x 150 x 30 mm
3 x 60 x 15 mm	5 x 160 x 40 mm
3 x 80 x 15 mm	5 x 180 x 40 mm
3 x 80 x 20 mm	5 x 200 x 40 mm
3 x 100 x 15 mm	5 x 220 x 40 mm
3 x 120 x 15 mm	6 x 120 x 40 mm
4 x 80 x 20 mm	6 x 140 x 40 mm
4 x 100 x 20 mm	6 x 150 x 40 mm
4 x 120 x 20 mm	6 x 160 x 40 mm
4 x 140 x 20 mm	6 x 180 x 40 mm
5 x 120 x 30 mm	6 x 200 x 40 mm
5 x 140 x 30 mm	6 x 220 x 40 mm

Kirschner Wire
Implantable Material

Packs of 10 units			
St. steel	Diameter	Length	Titanium Alloy
292.060	0.60mm	070mm	492.060
292.080	0.80mm	070mm	492.080
292.090	0.80mm	150mm	492.090
292.100 ¹	1.00mm	150mm	492.100
292.110	1.00mm	280mm	492.110
292.120 ¹	1.25mm	150mm	492.120
292.130	1.25mm	280mm	492.130
292.140	1.40mm	150mm	492.140
292.150	1.40mm	280mm	492.150
292.160 ¹	1.60mm	150mm	492.160
292.170	1.80mm	150mm	492.170
292.180	1.60mm	280mm	492.180

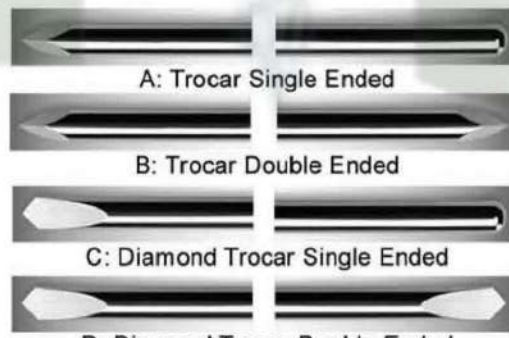

Kirschner Wire
Implantable Material

Packs of 10 units			
St. steel	Diameter	Length	Titanium Alloy
292.190	1.80mm	280mm	492.190
292.200 ¹	2.00mm	150mm	492.200
292.210	2.00mm	280mm	492.210
292.230	2.00mm	400mm	492.230
292.250 ¹	2.50mm	150mm	492.250
292.260	2.50mm	280mm	492.260
292.280	2.50mm	400mm	492.280
292.300 ¹	3.00mm	150mm	492.300
292.310	3.00mm	280mm	492.310
292.330	3.00mm	400mm	492.330

100% Quality Instruments

Orthopedic Instruments



Opposite Allama Iqbal Memorial Hospital,
1st Street, Muhammad Pura,
Sialkot, PAKISTAN.

 +92 320 5831682.

info@htsurgico.com

www.htsurgico.com