



+92 320 5831682.
info@htsurgico.com



HEAVY TECH SURGICO

Manufacturer & Exporter of
Dental Instruments

Opposite Allama Iqbal Memorial Hospital,
1st Street, Muhammad Pura,
Sialkot, PAKISTAN.

01

Diagnostics, Peridontal, Restorative & Lab. Instruments



02

Root Elevators



03

Extracting Forceps



04

Maxillofacial Surgery Instruments



05

Orthodontics Instruments



06

Dental Implant Instruments



07

Impression Trays



Handles for Mouth Mirrors - Mouth Mirrors

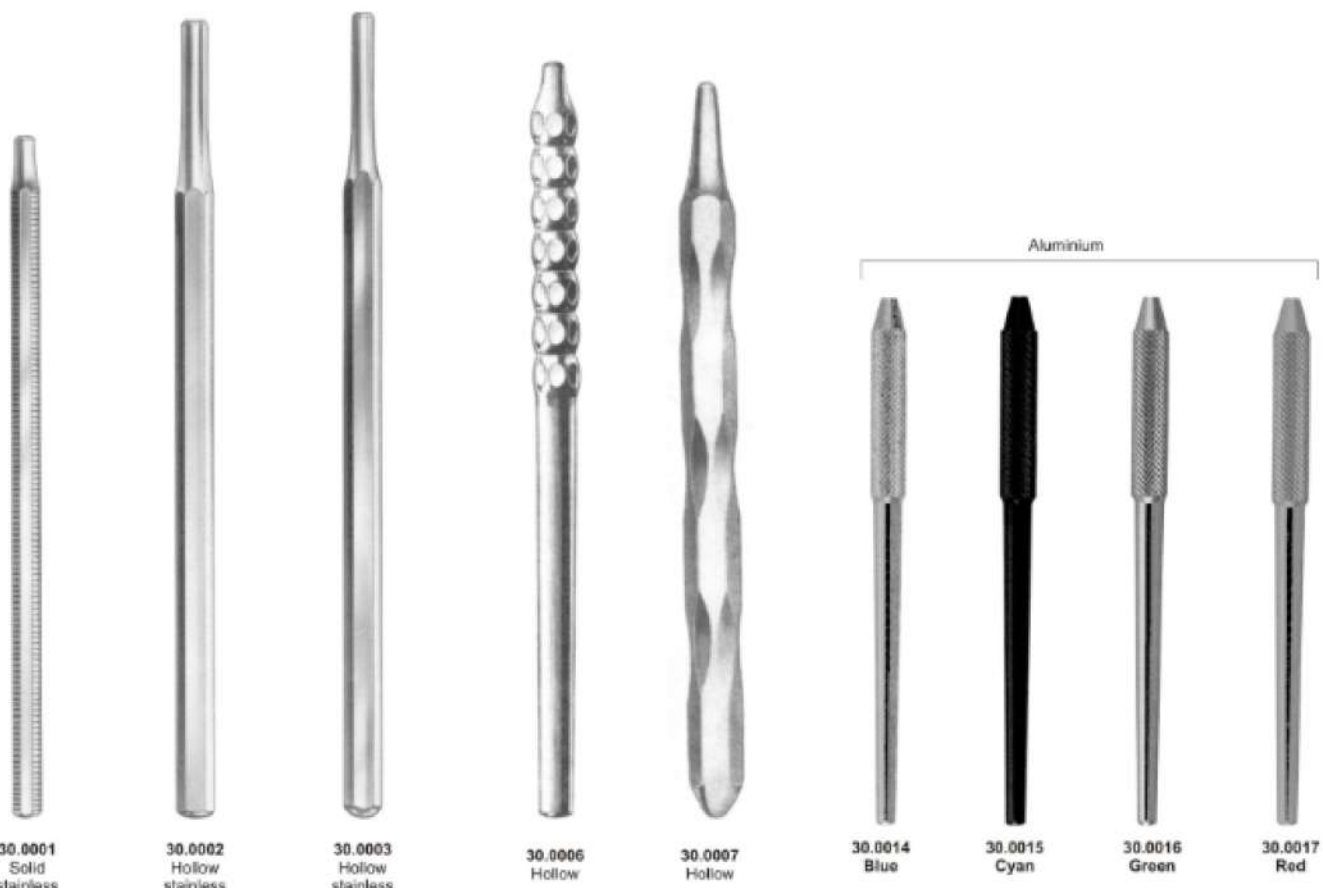

30.0001
Solid
stainless

30.0002
Hollow
stainless

30.0003
Hollow
stainless

30.0006
Hollow

30.0007
Hollow

30.0014
Blue

30.0015
Cyan

30.0016
Green

30.0017
Red



Plain



Magnifying



Rhodium

30.0023
Fig. 5
Ø24mm

30.0024
Fig. 4
Ø22mm

30.0025
Fig. 5
Ø24mm

30.0026
Fig. 4
Ø22mm

Tweezers



Adson
T.C.

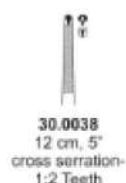

Ewald / Hudson



30.0041
Fig. 1
Flagg
16 cm
Smooth



30.0043
Fig. 1
Flagg
16 cm
Smooth



30.0046
Fig. 1
Semken Taylor
16 cm Str.



30.0047
Fig. 2
Semken Taylor
16 cm Cvd.



30.0054
Meriam
Toe Joint
16 cm



30.0055
Meriam
15 cm



30.0065
College
15 cm
Blue Coated

Explorers

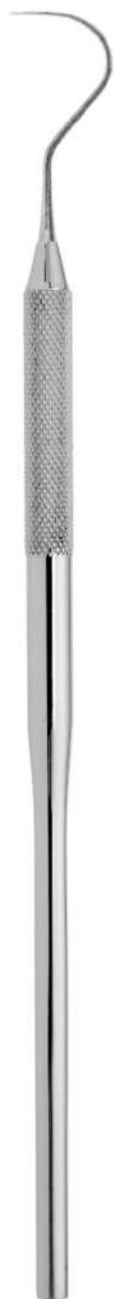

30.0105
Fig. 23



30.0106
Fig. 2



30.0107
Fig. 16



30.0108
Fig. 9



30.0109
Fig. 10



30.0110
Fig. 12



30.0111
Fig. 11



30.0112
Fig. 6



30.0113
Fig. 8



30.0114
Fig. 5



30.0115
Fig. 17



30.0116
Fig. 17A



30.0117
Fig. 3



30.0118
Fig. 3A



30.0119
Fig. 3R

Peridontal Probes

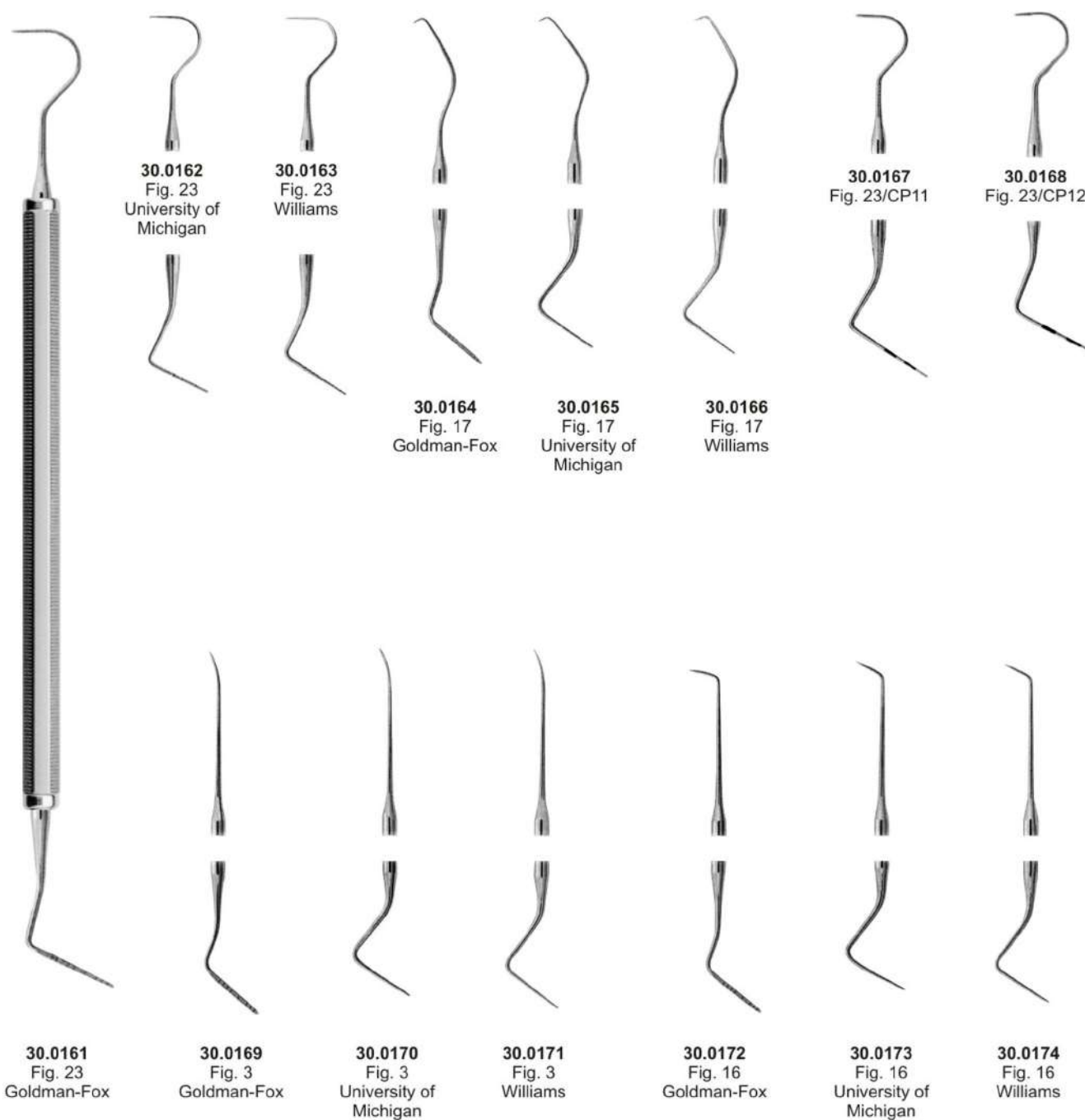

Peridontal Probes

Root-Canal Pluggers

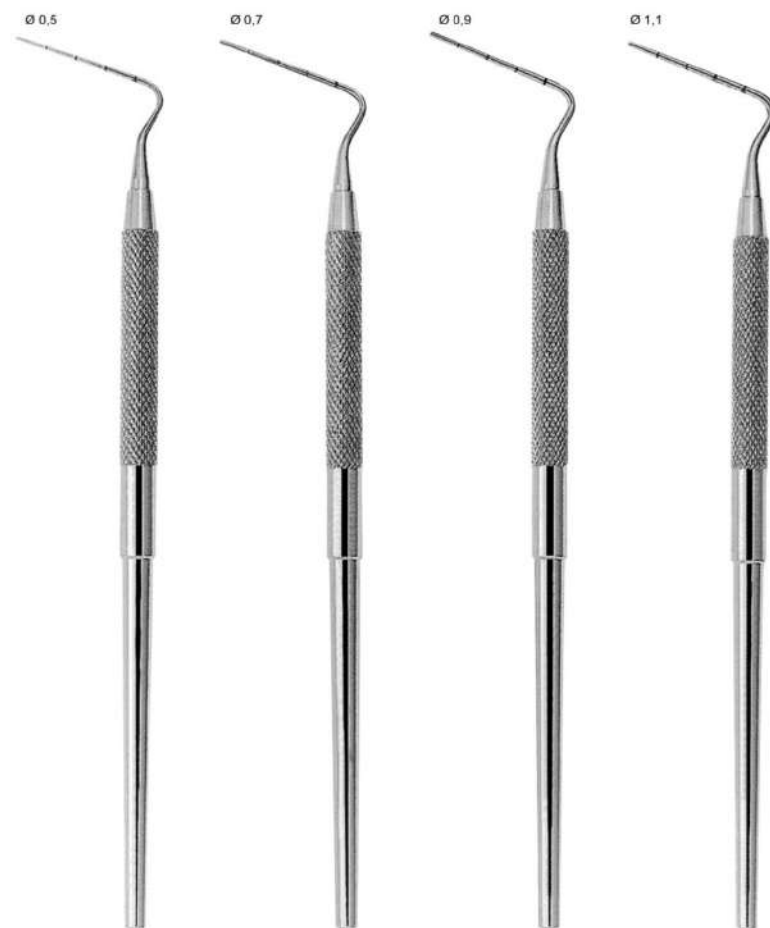
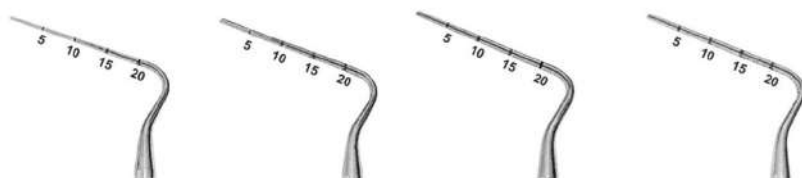

30.0182
Fig. 1
Luks

30.0183
Fig. 2
Luks

30.0184
Fig. 3
Luks

30.0185
Fig. 4
Luks

30.0186
Fig. 1
Vertical
condenser

30.0187
Fig. 2
Vertical
condenser

30.0188
Fig. 3
Vertical
condenser

30.0189
Fig. 4
Vertical
condenser

Filling Instruments

Markley Amalgam Instruments



30.0267
Fig. 0
FOC

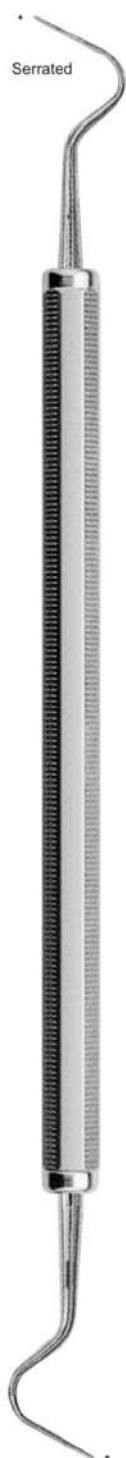

30.0268
Fig. 0S
FOC



30.0269
Fig. 1
FOC



30.0270
Fig. 1S
FOC



30.0271
Fig. 2
FOC



30.0272
Fig. 2S
FOC

Filling Instruments

Ladmore Burnisher



30.0279
Fig. 1
Westcott



30.0280
Fig. 2
Westcott



30.0281
Fig. 2
Ladmore



30.0282
Fig. 3
Ladmore



30.0283
Fig. 18
Ball



30.0284
Fig. 26-27S
Ball



30.0285
Fig. 27-29
Ball



30.0286
Fig. A



30.0287
Fig. W3



30.0288
Fig. NYU/B2



30.0289
Fig. 2/31

Plastic Filling Instruments with Titanium Nitride Coated Tips

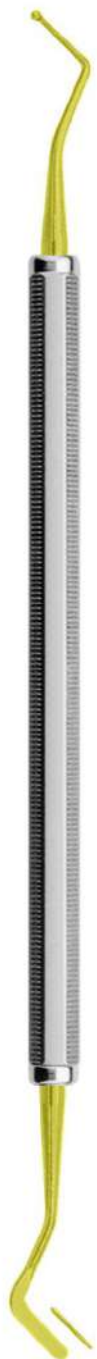

30.0308
Fig. 1
Gold Tip



30.0309
Fig. 2
Gold Tip



30.0310
Fig. 3
Gold Tip



30.0311
Fig. 2
Gold Tip



30.0312
Fig. 2
Gold Tip

Carvers Instruments

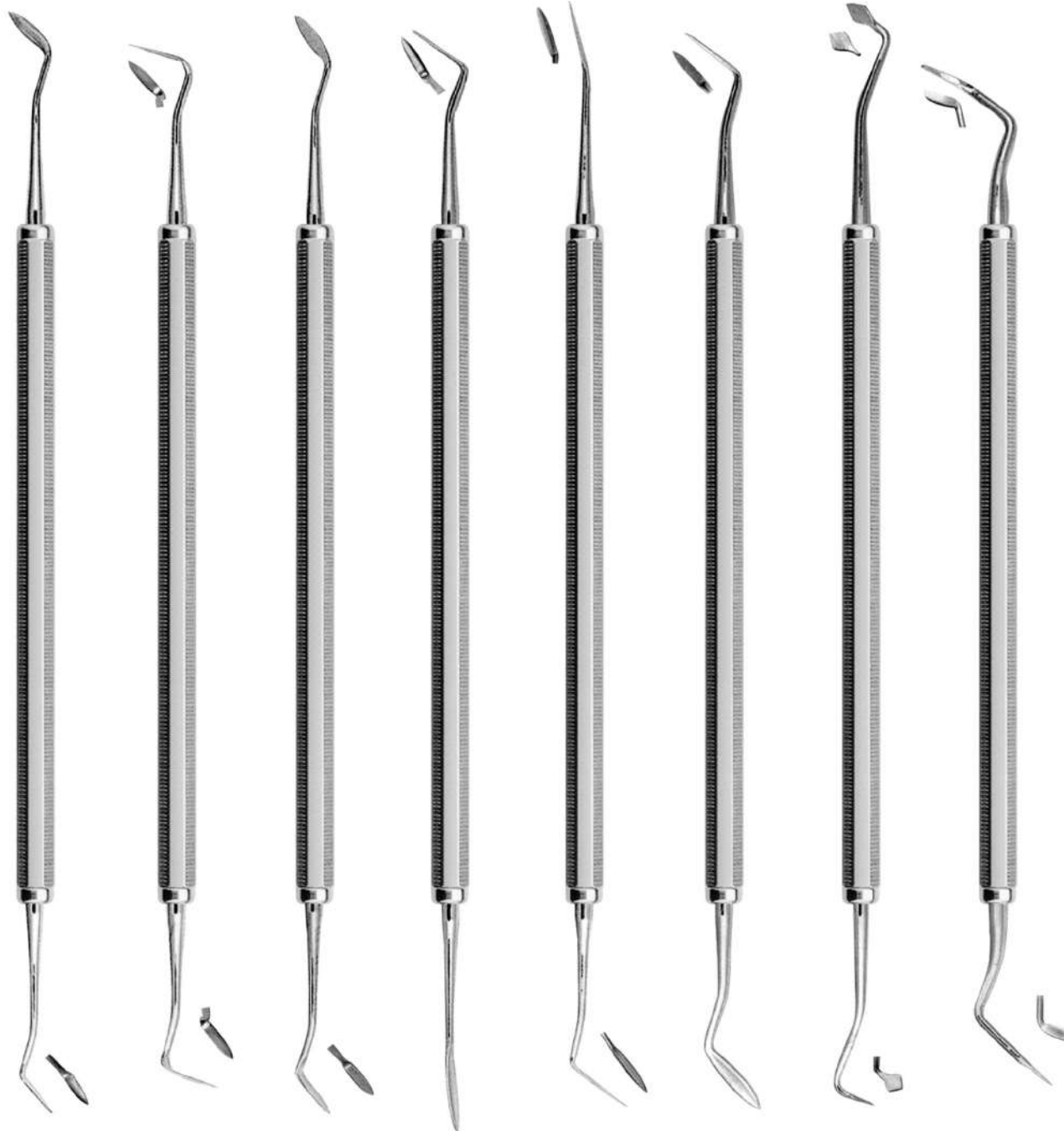

30.0413
Fig. 1/2
Hollenback

30.0414
Fig. 3
Hollenback

30.0415
Fig. 3S
Hollenback

30.0416
Fig. 1
Ward

30.0417
Fig. 1S
Ward

30.0418
Fig. 2
Ward

30.0419
Fig. 1
Frahm

30.0420
Fig. 2
USC

Carvers Instruments

Graded Handle Hylin Carver



Cement Spatulas



30.0443
Fig. 1



30.0444
Fig. 2



30.0445
Fig. 3



30.0446
Fig. 00



30.0447
Fig. 0



30.0448
Fig. 1



30.0449
Fig. 2



30.0450
Fig. 3



30.0451
Fig. 4



30.0452
Weston



30.0453



30.0454

Peridontal Instruments

Sugarman File Рашпиль

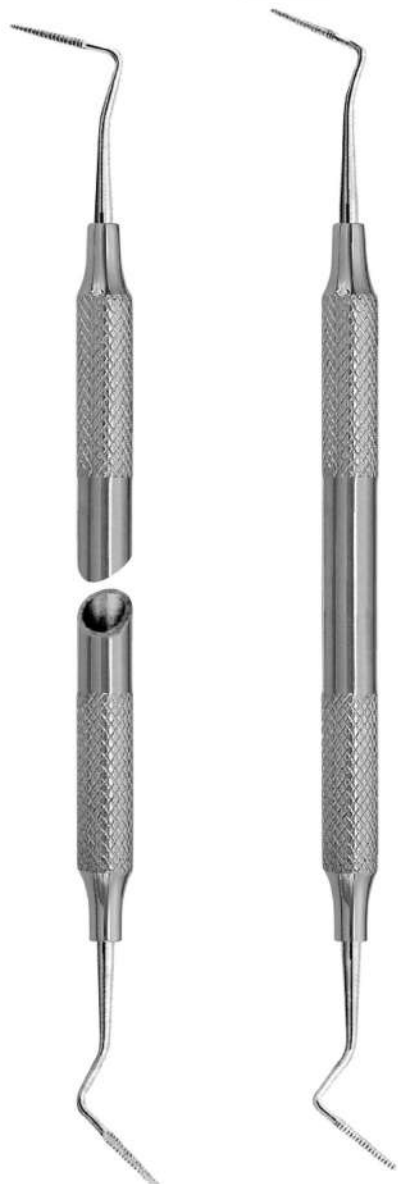

30.0546
Fig. 1S/2S
Sugarman

30.0547
Fig. 3S/4S
Sugarman

Ochsenbein Chisels File Ochsenbein Рашпиль Долота

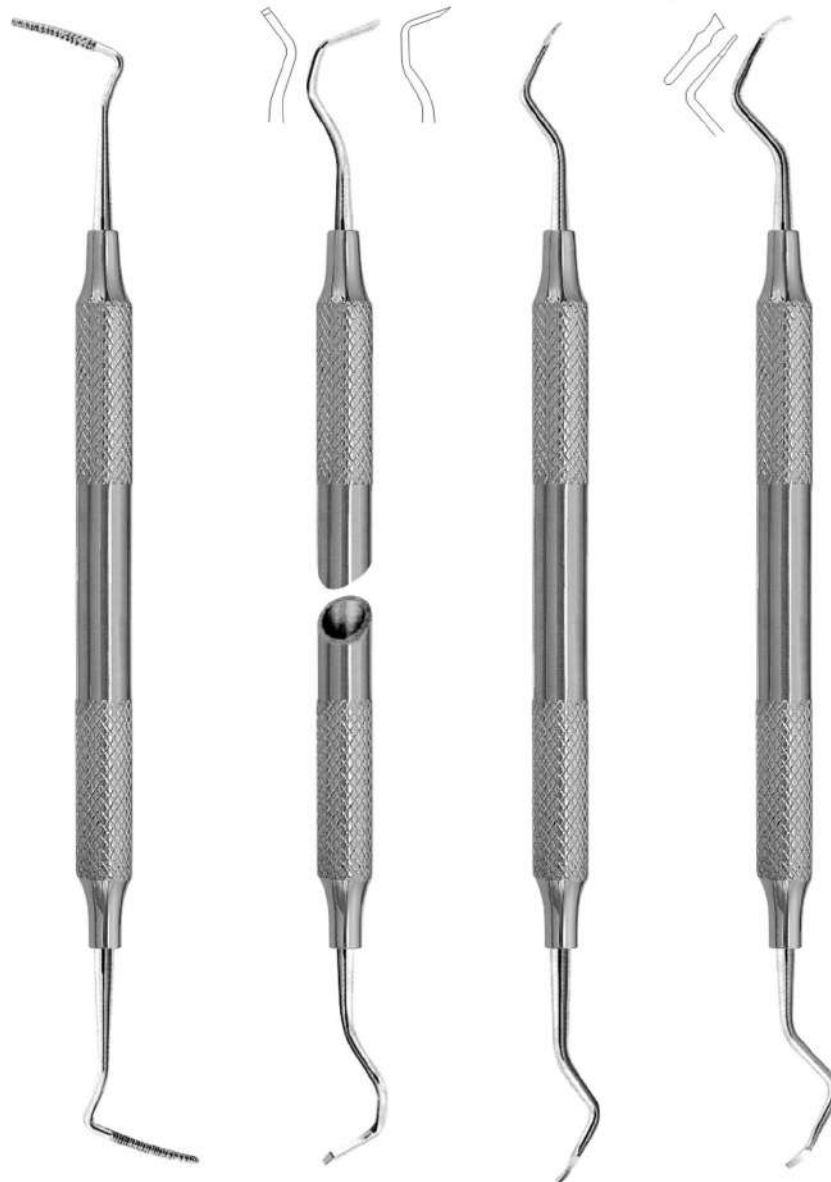

30.0548
Fig. 9/10
Schluger

30.0549
Fig. 3
Ochsenbein

30.0550
Fig. 4
Ochsenbein

30.0551
Fig. 36/37
Rhodes Back-Action
Зворотної дії

Peridontal Instruments

Scalers



30.0694
Fig. U15/33
Towner Jacquette



30.0695
Fig. U15/30
Towner Jacquette



30.0696
Fig. H5/33



30.0697
Fig. H6/H7



30.0698
Fig. 1/2

Peridontal Instruments

Scalers



30-0699
Fig. 1



30.0700
Fig. 1L
Left



30.0701
Fig. 1R
Right

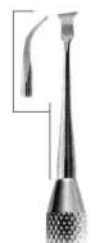

30.0702
Fig. 2L
left



30.0703
Fig. 2R
Right



30-0704
Fig. 33



30-0705
Fig. H5
Hygienist



30.0706
Fig. H6
Hygienist



30.0707
Fig. H7
Hygienist

Wax Knives



30.0708
13 cm

Fahamenstock

30.0709
17 cm

30.0710
13 cm

rostfrei/stainless
inox

30.0711
17 cm

30.0712
13 cm

Lessmann

30.0713
17 cm

30.0714
13 cm

Ermert

Alginate & Plaster Spatulas



30.0731
Fig. 7
19.5 cm

30.0732
Fig. 8
20 cm

30.0733
Fig. 9
22.5 cm

30.0734

30.0735

Articulators



30.0753

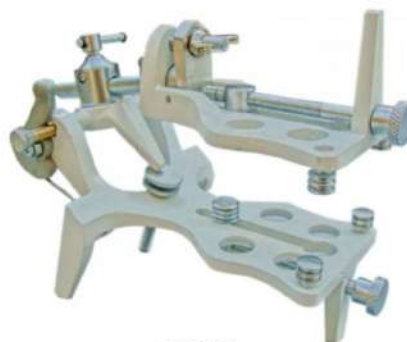

30.0754



30.0755
Copper Black Metallic
Мідний Чорний Металічний



30.0756
Stainless Steel Finishing
Нержавіюча сталь
30-0757
Royal Blue
королівський синій



30.0758



30.0759



30.0760



30.761



30.0762



30.0763

Root Elevators



31.0779
Fig-1
Bein 2 mm



31.0780
Fig-2
Bein 3 mm



31.0781
Fig-3
Bein 4 mm



31.0782
Fig-4
Bein 2,5 mm



31.0783
Fig-5
Bein 3 mm



31.0784
Fig-6
Bein 4 mm



31.0785
Fig-7
white



31.0786
Fig-8
white



31.0787
Fig-9
Berten

Root Elevators

3 mm



31.0788
Fig-1
Fig. Рис. 1F
Apical 301



31.0789
Fig-2
Apical 302
Апікальний 302

31.0790
Fig-3
Apical 303
Апікальний 303



31.0791
Fig-4
Apical 304
Апікальний 304



31.0792
Fig-5
12 A



31.0793
Fig-6
34 S Seldin



31.0794
Fig-7
34 Seldin



31.0795
Fig-8



31.0796
Fig-9
Flohr



31.0797
Fig-10
Flohr



31.0798
Fig-11
Flohr

Root Elevators



31.0808
Fig-21
1 L Seldin



31.0809
Fig-22
1 R Seldin



31.0810
Fig-23
4 L Seldin



31.0811
Fig-24
4 R Seldin



31.0812
Fig-25



31.0813
Fig-26



31.0814
Fig-27
27 Cryer



31.0815
Fig-28
28 Cryer



31.0816
Fig-27 S
27 S Cryer



31.0817
Fig-28 S
28 S Cryer

Root Elevators



31.0818
Fig-29
(344)



31.0819
Fig-30
(345)



31.0820
Fig-31



31.0821
Fig-32



31.0822
Fig-33
Miller 1



31.0823
Fig-34
Miller 2



31.0824
Fig-35
Miller 3



31.0825
Fig-36
Miller 4

Root Elevators



31.1000
Fig. Рис. 1
Heidbrink



31.1001
Fig. Рис. 2
Heidbrink



31.1002
Fig. Рис. 3
Heidbrink



31.1003
Fig. Рис. 1
Warwick-James



31.1004
Fig. Рис. 2
Warwick-James



31.1005
Fig. Рис. 3
Warwick-James



31.1006
Fig. Рис. 1
Heidbrink



31.1007
Fig. Рис. 2
Heidbrink



31.1008
Fig. Рис. 3
Heidbrink

Root Elevators

SYNDESMOTOMES



31.1009
Fig. Рис. 1
Chompret



31.1010
Fig. Рис. 2
Chompret



31.1011
Fig. Рис. 3
Chompret



31.1012
Fig. Рис. 4
Chompret

Extracting Forceps (English)



32.1028
1
upper laterals and canines
obere Schneide- und Eckzähne
incisives et canines supérieures
incisivos y caninos superiores
Для верхніх бокових зубів та іклів

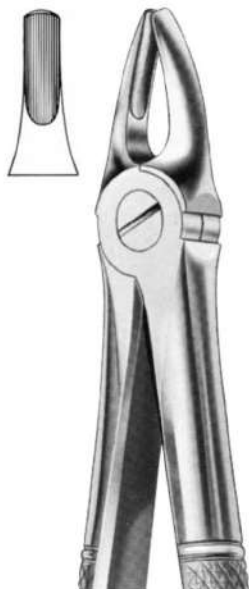

32.1029
2
upper laterals and canines
obere Schneide- und Eckzähne
incisives et canines supérieures
incisivos y caninos superiores
Для верхніх бокових зубів та іклів



32.1030
3
upper laterals and canines
obere Schneide- und Eckzähne
incisives et canines supérieures
incisivos y caninos superiores
Для верхніх бокових зубів та іклів



32.1031
4
lower laterals and canines
untere Schneide- und Eckzähne
incisives et canines inférieures
incisivos y caninos inferiores
Для нижніх бокових зубів та іклів

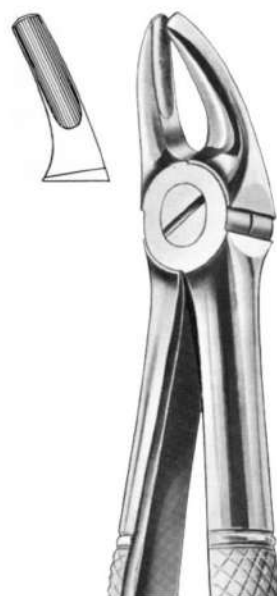

32.1032
7
upper premolars
obere Prämolaren
prémolaires supérieures
prémolares superiores
Для верхніх премолярів

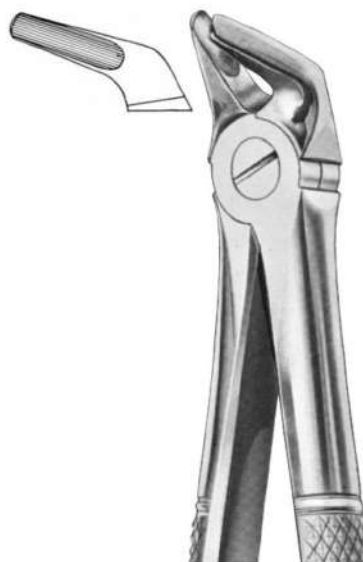

32.1033
8
lower premolars
untere Prämolaren
prémolaires inférieures
prémolares inferiores
Для нижніх премолярів

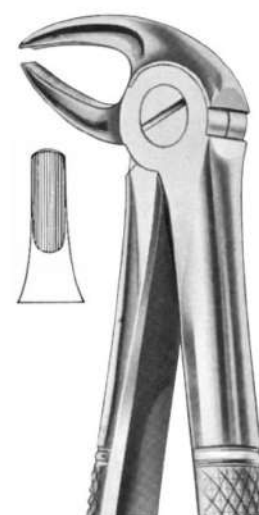

32.1034
13
lower premolars
untere Prämolaren
prémolaires inférieures
prémolares inferiores
Для нижніх премолярів

Extracting Forceps (English)



**32.1056
33A**
lower roots
untere wurzeln
recines inférieures
raíces inferiores
Для нижніх коренів зубів

**32.1057
33B**
lower roots
untere wurzeln
recines inférieures
raíces inferiores
Для нижніх коренів зубів

**32.1058
33L**
lower roots
untere wurzeln
recines inférieures
raíces inferiores
Для нижніх коренів
зубів

**32.1059
33S**
lower roots, for children
untere Wurzeln, für kinder
racines inférieures, pour enfants
raíces inferiores, para niños
Для нижніх коренів зубів,
для дітей

**32.1055
33**
lower roots
untere wurzeln
recines inférieures
raíces inferiores
Для нижніх коренів зубів



**32.1061
Fig. 34**
Upper incisors and premolars
deep-gripping
Incisivi e premolari superiori
attacco profondo
Incisives et prémolaires supérieurs
à attaque profonde
Incisivos y premolares superiores
a sujeción profunda
Для верхніх різців та премолярів
Глибоке захоплення

**32.1062
Fig. 35**
Upper incisors and premolars
deep-gripping
Incisivi e premolari superiori
attacco profondo
Incisives et prémolaire supérieurs
à attaque profonde
Incisivos y premolares superiores
a sujeción profunda
Для верхніх різців та премолярів
Глибоке захоплення

**32.1063
Fig. 35N**
Upper incisors and premolars
deep-gripping
Incisivi e premolari superiori
attacco profondo
Incisives et prémolaire supérieurs
à attaque profonde
Incisivos y premolares superiores
a sujeción profunda
Для верхніх різців та премолярів
Глибоке захоплення



**32.1060
Fig. 33C**
Lower roots



**32.1064
Fig. 33M**
Lower roots
with long beak



**32.1065
Fig. 36**
Lower premolars deep-gripping
Premolari inferiori attacco profondo
Prémolaires inférieurs à attaque profonde
Premolares inferiores a sujeción profunda
Для нижніх премолярів Глибоке
захоплення



**32.1066
Fig. 36N**
Lower premolars deep-gripping
Premolari inferiori attacco profondo
Prémolaires inférieurs à attaque profonde
Premolares inferiores a sujeción profunda
Для нижніх премолярів Глибоке
захоплення



**32.1067
37**
upper incisors, for children
oberer Schneidezähne, für kinder
incisivos superiores, pour enfants
raíces superiores, para niños
Для верхніх різців, для дітей oberer

Extracting Forceps (English)



32.1106
73 A
lower molars
untere Molaren
molaires inférieures
molares inferiores
Для нижніх молярів



32.1107
73 S
lower molars
untere Molaren
molaires inférieures
molares inferiores
Для нижніх молярів



32.1108
73 B
lower molars for children
untere Molaren für Kinder
molaires inférieures,
pour enfants
molares inferiores,
para niños
Для нижніх молярів
для дітей



32.1111
73 K
lower molars for children
untere Molaren für Kinder
molaires inférieures,
pour enfants
molares inferiores,
para niños
Для нижніх молярів
для дітей



32.1109
74
lower roots
untere Wurzeln
racines inférieures
raíces inferiores
Для нижніх коренів
зубів



32.1110
74 D
lower roots
untere Wurzeln
racines inférieures
raíces inferiores
Для нижніх коренів
зубів

Extracting Forceps (English)

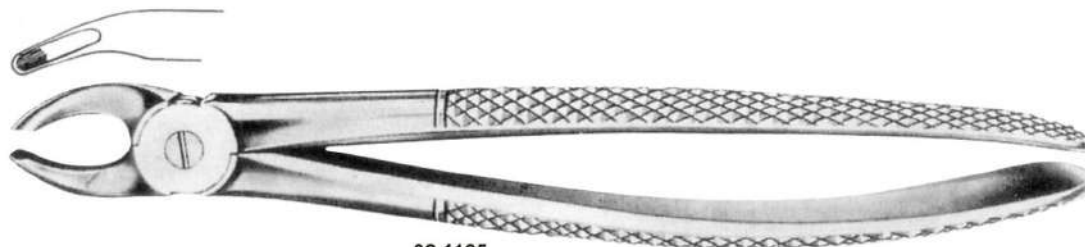

32.1165
Fig. 158
Children's upper teeth molars universal

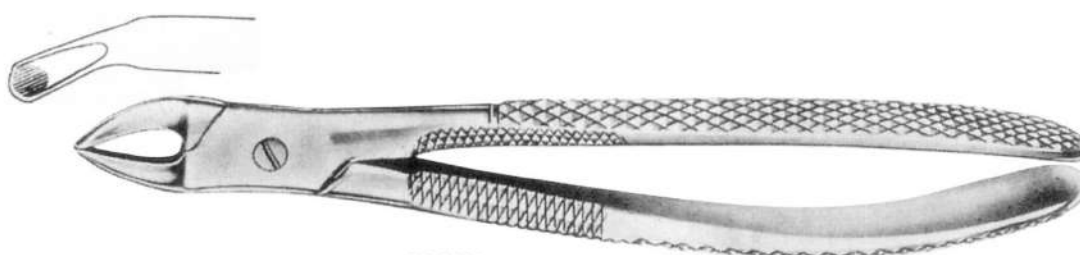

32.1166
Fig. 159
Children's lower molars universal

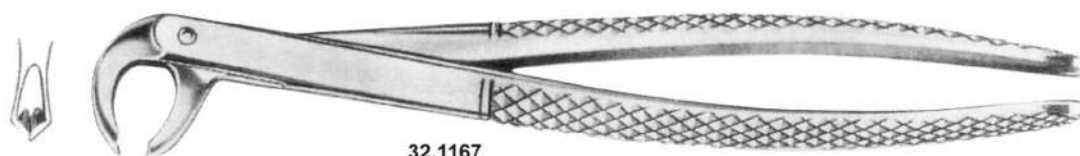

32.1167
Fig. 160
Children's upper lower universal (hawk's bill)



32.1168
Fig. 161
Children's lower & roots

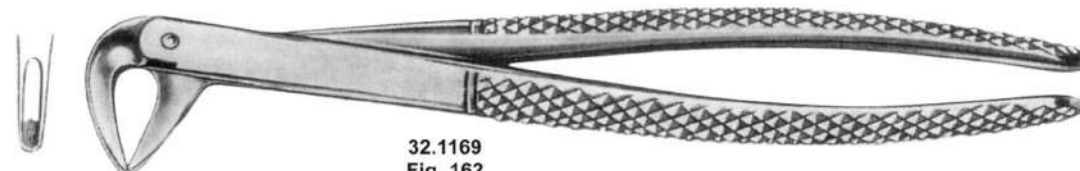

32.1169
Fig. 162
Children's upper centrals



32.1170
Fig. 163
Children's upper centrals

Extracting Forceps (English)



32.1180
Busch
lower roots
untere Wurzeln
racines inférieures
raíces inferiores
Для нижніх коренів
зубів



32.1181
Busch
lower roots
untere Wurzeln
racines inférieures
raíces inferiores
Для нижніх коренів
зубів



32.1182
Witzel
lower roots
obere Wurzeln
racines supérieures
raíces superiores
Для нижніх коренів
зубів



32.1183
Fig. 146
Upper and lower roots
deep-gripping
Radici superiori e inferiori
attacco profondo
Racines supérieurs et inférieurs
à attaque profonde
Raíces superiores y inferiores
a sujeción profunda
Для верхніх та нижніх коренів
зубів Глибоке захоплення



32.1184
Fig. 333S
Very thin lower
roots
Radici inferiori
molto sottili
Racines inférieurs
très fines
Raíces inferiores
muy delgada
Дуже тонкі Для
нижніх коренів зубів



32.1185
Fig. 151
upper roots
Radici superiori
Racines supérieurs
Raíces superiores
Для верхніх коренів
зубів



32.1186
Fig. 351S
Very thin upper roots
Radici superiori
molto sottili
Racines supérieurs
très fines
Raíces superiores
muy delgadas
Дуже тонкі Для
верхніх коренів зубів

Extracting Forceps (Children)



32.1187
Fig. 137
upper incisors
obere Schneidezähne
incisives supérieures
incisivos superiores
Для верхніх різців



32.1188
Fig. 139
upper premolars
obere Prämolaren
prémolaires supérieures
premolares superiores
Для верхніх премолярів

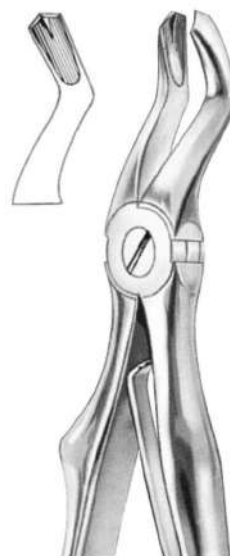

32.1189
Fig. 3
upper molars
obere Molaren
molaires supérieures
molares superiores
Для верхніх молярів

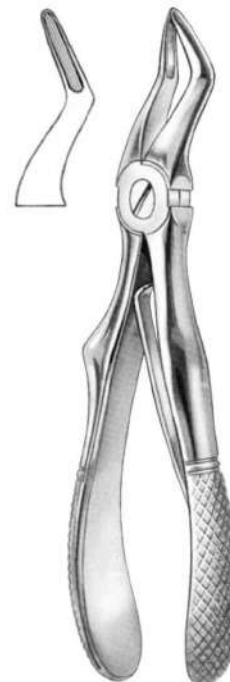

32.1190
Fig. 51S
upper roots
obere Wurzeln
racines supérieures
raices superiores
Для верхніх коренів зубів



32.1191
Fig. 5
lower incisors
untere Schneidezähne
incisives inférieures
incisivos inferiores
Для нижніх різців



32.1192
Fig. 6
lower molars
untere Molaren
molaires inférieures
molares inferiores
Для нижніх молярів



32.1193
Fig. 7
lower roots
untere Wurzeln
racines inférieures
raices inferiores
Для нижніх коренів
зубів

Extracting Forceps (Children)



32.1215
Lower
Capture Forceps Retain
Pediatric Extractions
Щипці для захвату нижніх
зубів з фіксатором
Педіатричне видалення
зубів



32.1216
Upper
Capture Forceps Retain
Pediatric Extractions
Щипці для захвату верхніх
зубів з фіксатором
Педіатричне видалення
зубів



32.1217
Lower
Capture Forceps Retain
Pediatric Extractions
Щипці для захвату нижніх
зубів з фіксатором
Педіатричне видалення
зубів



32.1218
Upper
Capture Forceps Retain
Pediatric Extractions
Щипці для захвату верхніх
зубів з фіксатором
Педіатричне видалення
зубів



32.1219
Lower
Capture Forceps Retain
Pediatric Extractions
Щипці для захвату нижніх
зубів з фіксатором
Педіатричне видалення
зубів



32.1220
Upper
Capture Forceps Retain
Pediatric Extractions
Щипці для захвату верхніх
з фіксатором Педіатричне
видалення зубів

Extracting Forceps

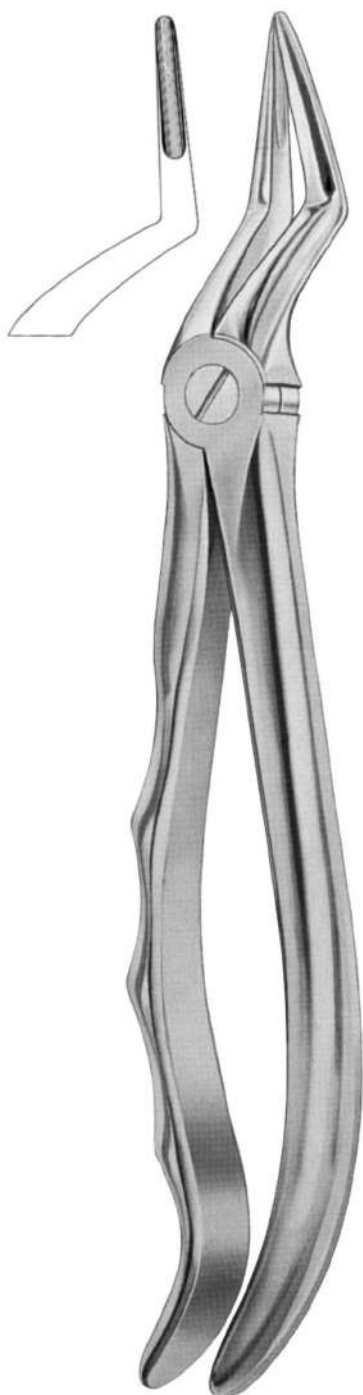

32.1337
51 L
 upper roots
 obere Wurzeln
 racines supérieures
 raíces superiores
 Для верхніх коренів
 зубів



32.1338
52
 upper roots
 obere Wurzeln
 racines supérieures
 raíces superiores
 Для верхніх коренів
 зубів



32.1339
54
 for separating upper molars
 Spaltzange für obere
 Molaren
 à séparer molaires
 supérieures
 para separar molares
 superiores
 Для розділення верхніх
 молярів

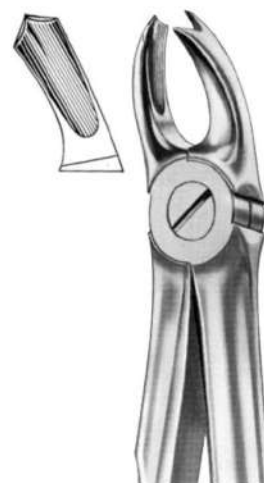

32.1340
65 R
 upper molars, right
 obere Molaren, rechts
 molaires supérieures
 droites
 molares superiores
 derechos
 Для верхніх молярів,
 справа



32.1341
65 L
 upper molars, left
 obere Molaren, links
 molaires supérieures
 gauches
 molares superiores
 izquierdos
 Для верхніх молярів,
 зліва



32.1342
67
 upper third molars
 obere dritte Molaren
 troisièmes molaires
 supérieures
 terceros molares
 superiores
 Для верхніх третіх
 молярів

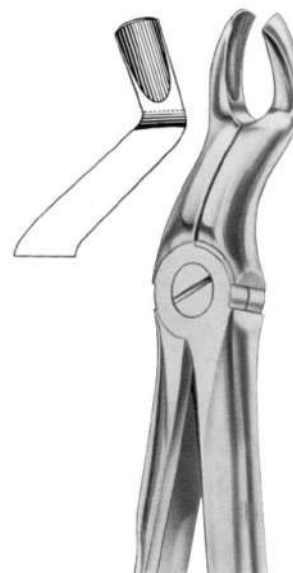

32.1343
67 A
 upper third molars
 obere dritte Molaren
 troisièmes molaires
 supérieures
 terceros molares
 superiores
 Для верхніх третіх
 молярів

Bone Rongeurs & Tissue Nippers



32.1374
Kleinert-Kutz
16cm



32.1375
Cohen 10cm
Tissue nippers,
Tronchesini per gengive
Pinces à couper le tissu
Alicatess para encías
Хірургічні гострозубці



32.1376
Cohen 14cm
Tissue nippers,
Tronchesini per gengive
Pinces à couper le tissu
Alicatess para encías
Хірургічні гострозубці



32.1377
Beyer
18.5cm



32.1378
Clevelanda
14cm



32.1379
Rongeurs
16.5cm, 6 1/2"
Кусачки



32.1380
Rongeurs
Side Cutting
16.5cm, 6 1/2"
Кусачки для 3
бокової обрізки



32.1381
Round beaks
Double Action
17 cm, 6 1/2"
Круглі кінчики у
вигляді дзьоба
Подвійна дія

Bone Rongeurs



32.1382
Ruskin Rongeur
17.8cm Long
Double Action For
Increased Leverage



32.1383
Ruskin-Mini
15.5 cm
Bone rongeurs,
multiple action
Кісткові кусачки,
багатофункціональні



32.1384
Bohler
16 cm, 6 3/4"
Straight
Прямі



32.1385
Böhler
15 cm
Bone cutting forceps,
multiple action
Щипці для розрізання кісток,
багатофункціональні



32.1386
LISTON BONE
Cutting Forceps
14 cm, 5 1/2"
Щипці для розрізання
кісток



Kerrison
15 cm

32.1387
2 mm

32.1388
3 mm

32.1389
5 mm

Bone Rongeurs



32.1404
Cleveland 10
17 cm, 6 $\frac{3}{4}$ "



32.1405
Cleveland-Gardner
end Cutting, 6 $\frac{1}{2}$ "



32.1406
Jansen
17.5 cm

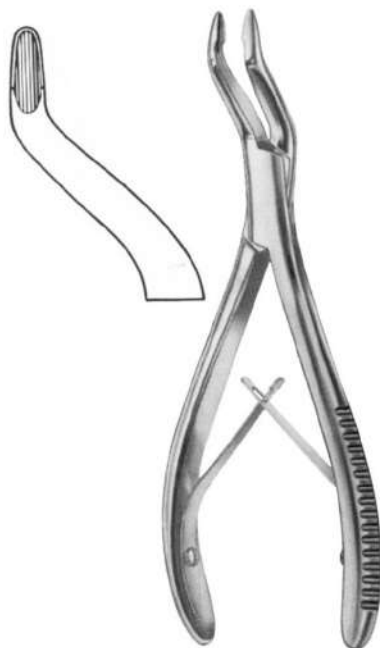

32.1407
Jansen
18 cm, 7"



32.1408
BAGi
Slight Curved 7"
Злегка зігнуті

Dental Syringes



32.1409
Aluminium - Dark
1.8 ml



32.1410
Aluminium - Silver
1.8 ml



32.1411
Aluminium - Orange
1.8 ml



32.1412
Aluminium - Green
1.8 ml



32.1413
Aluminium - Blue
1.8 ml

Dental Syringes

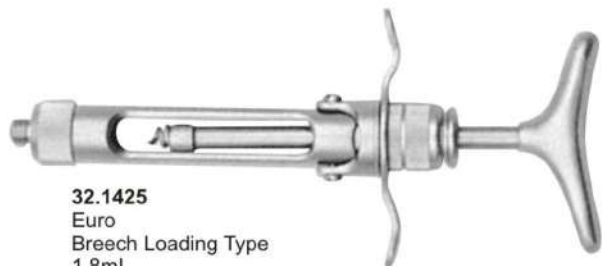

32.1425
Euro
Breech Loading Type
1,8ml.
Європейський тип,
заряджається з казенного
боку 1,8мл.

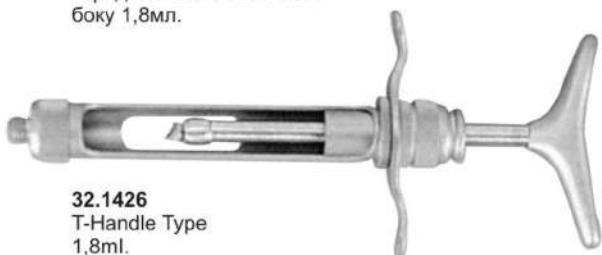

32.1426
T-Handle Type
1,8ml.
Тип з ручкою у
формі Т 1,8мл.



32.1427
Euro Type
1,8ml.
Європейський
тип 1,8мл.



32.1428
3- Ring Type
1,8ml.
Тип «3-Кільця»
8мл.

Manual Aspirating Syringes
Шприци для ручного відсмоктування



32.1429
Euro Type 1,8ml.
Європейський тип 1,8мл.



32.1430
Type A 1,8ml.
Тип А 1,8мл



32.1431
Type A
1,8ml.
Тип А 1,8мл



32.1432
Type C
1,8ml.
Тип С 1,8мл



32.1433
Euro Type 1,8ml.
Європейський тип 1,8мл



32.1434
3- Ring Type
1,8ml.
Тип «3-Кільця»
1,8мл



32.1435
2-Ring Type
1,8ml.
Тип «2-Кільця»
1,8мл



32.1436

Dental Syringes

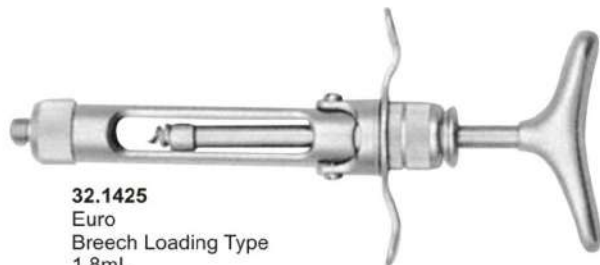

32.1425
Euro
Breech Loading Type
1,8ml.
Європейський тип,
заряджається з казенного
боку 1,8мл.

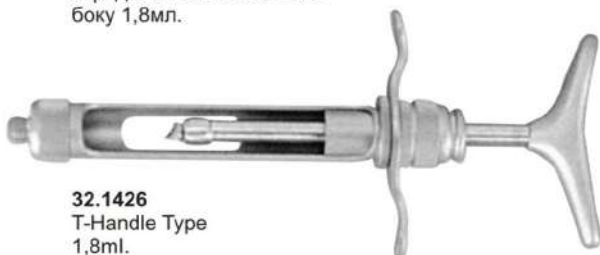

32.1426
T-Handle Type
1,8ml.
Тип з ручкою у
формі Т 1,8мл.



32.1427
Euro Type
1,8ml.
Європейський
тип 1,8мл.



32.1428
3- Ring Type
1,8ml.
Тип «3-Кільця»
8мл.

Manual Aspirating Syringes
Шприци для ручного відсмоктування



32.1429
Euro Type 1,8ml.
Європейський тип 1,8мл.



32.1430
Type A 1,8ml.
Тип А 1,8мл



32.1431
Type A
1,8ml.
Тип А 1,8мл



32.1432
Type C
1,8ml.
Тип С 1,8мл



32.1433
Euro Type 1,8ml.
Європейський тип 1,8м



32.1434
3- Ring Type
1,8ml.
Тип «3-Кільця»
1,8мл



32.1435
2-Ring Type
1,8ml.
Тип «2-Кільця»
1,8мл



32.1436

Dental Syringes



32.1437
Euro
Breech loading Type
1,8ml.
Європейський тип,
заряджається з казенного
боку 1,8мл.

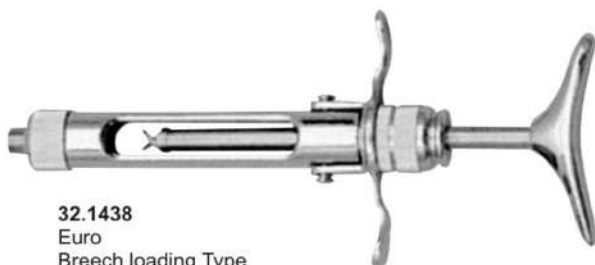

32.1438
Euro
Breech loading Type
1,8ml.
Європейський тип,
заряджається з
казенного боку 1,8мл

Self Aspirating Syringes
Самовсмоктуючі шприци



32.1439
Disc system
1,8ml.
Дискова система
1,8мл.



32.1440
Disc system
1,8ml.
Дискова система
1,8мл.



32.1441
Disc system
1,8ml.

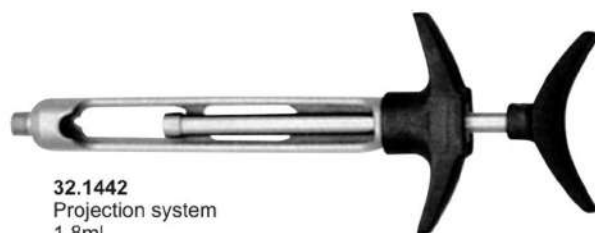

32.1442
Projection system
1,8ml.
Проекційна
система 1,8мл



32.1443
Projection system
1,8ml.
Проекційна
система 1,8мл

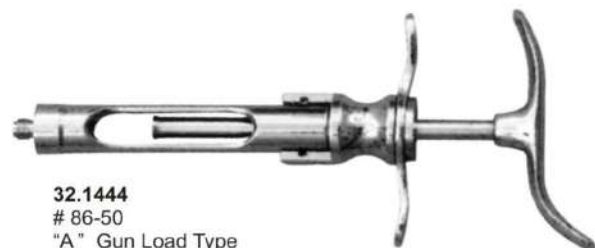

32.1444
86-50
"A" Gun Load Type
Тип "А", заряджається
по типу пістолета

Scalpel Handles



33.1445
Fig.3
12.7cm 5"



33.1446
Fig.3G
12.7cm 5"



33.1447
Fig.3L
21cm 8 1/4"



33.1448
Fig.7
16.5cm 6 1/2"



33.1449
Fig.4
13.7cm 5 1/2"



33.1450
Fig.4L
21.8cm 8 1/2"



33.1451
11 cm
4 1/4"



33.1452
11.5cm
4 1/2"



33.1453
12.7 cm
5"



33.1454
12.7 cm
5"



33.1455
13.3 cm
5 1/4"



33.1456
12 cm
4 3/4"



33.1457
Fig. 5



33.1458
Fig. 5A

Needle Holders



Castroviejo
 33.1464 130mm
 33.1465 150mm
 33.1466 180mm



Halsey
 33.1467 130mm



Baumgartner
 33.1468 130mm



Derf
 33.1469 120mm



Delicate
 33.1470 150mm



Adson
 33.1471 170mm



Mayo-Hegar
 33.1472 130mm
 33.1473 160mm
 33.1474 180mm
 33.1475 200mm



Crile Wood
 33.1476 150mm

Needle Holders



Eiselsberg Mathieu
33.1477 190mm



Mathieu
33.1478 140mm
33.1479 170mm
33.1480 200mm
33.1481 240mm



Mathieu
33.1482 140mm
33.1483 170mm



Boynton
33.1484 120mm



Eiselsberg Mathieu
33.1485 190mm



Mathieu
33.1486 140mm
33.1487 170mm
33.1488 200mm
33.1489 240mm



Mathieu
33.1490 140mm
33.1491 170mm



Boynton
33.1492 120mm

Needle Holders



Castroviejo Scissors
33.1516 15cm Str.
Titanium



Castroviejo Scissors
33.1517 15cm Cvd.
Titanium



Castroviejo Needle Holders
33.1518 16cm Str.
Titanium



Castroviejo Needle Holders
33.1519 16cm Cvd.
Titanium



Castroviejo Needle Holders T.C
33.1520 14cm Str.



Castroviejo Needle Holders T.C
33.1521 14cm Cvd.

For 5-0 to 7-0 Sutures

For 5-0 to 7-0 Sutures

For 5-0 to 7-0 Sutures

For 5-0 to 7-0 Sutures

For 5-0 to 7-0 Sutures



Castroviejo Needle Holders T.C
33.1522 16cm Str.



Castroviejo Needle Holders T.C
33.1523 16cm Cvd.



Castroviejo Needle Holders T.C
33.1524 18cm Str.



Castroviejo Needle Holders T.C
33.1525 18cm Cvd.



Castroviejo Needle Holders T.C
33.1526 14cm fine

Surgical Scissors



Iris
33.1527 115mm
Straight



Iris
33.1528 115mm
Curved



Micro Iris
33.1529 90mm
Curved



Iris
33.1530 115mm
Angular



Iris
33.1531 115mm
Curved

SURGICAL SCISSORS, SAW EDGE

SAW EDGE



Goldman-Fox
33.1532 130mm
Saw edge,
Straight



Goldman-Fox
33.1533 130mm
Saw edge,
Curved



Goldman-Fox
33.1534 130mm
Saw edge,
Double Curved

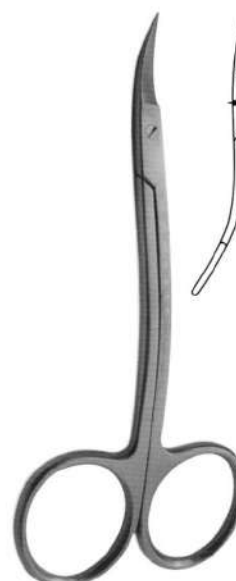

La Grange
33.1535 115mm
Saw edge,
Double Curved



Neumann
33.1536 120mm
Saw edge,
Double Curved

Surgical Scissors, Superior Cut



Iris
33.1594 115mm
Straight



Iris
33.1595 115mm
Curved



La Grange
33.1596 115mm
Double
Curved



Goldman Fox
33.1597 130mm
Straight



Goldman Fox
33.1598 130mm
Curved



Kelly
33.1599 160mm
Curved

Surgical Scissors



Zed
33.1600 110mm
Saw edge



Zed
33.1601 135mm
Saw edge



Zed
33.1602 110mm
Saw edge



Zed
33.1603 135mm
Saw edge

SURGICAL SCISSORS, TITANIUM

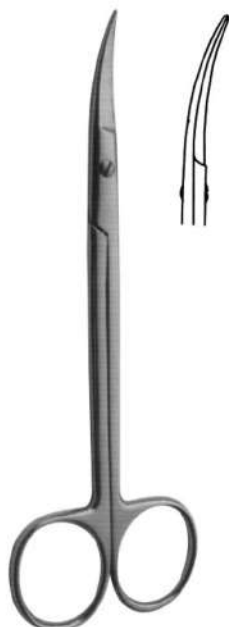

Kelly (Titanium)
33.1604 160mm
Curved



Goldman Fox (Titanium)
33.1605 130mm
Curved



(Titanium)
33.1606 180mm
Straight



(Titanium)
33.1607 180mm
Curved

Dressing Forceps & Tongue Forceps



Straight
прямий

33.1633
Gross-Maier
20 cm



Curved
зігнутий

33.1634
Gross-Maier
20 cm



Straight
прямий

33.1635
Gross-Maier
25 cm



Curved
зігнутий

33.1636
Gross-Maier
25 cm



**Jacket Grip
Crown Plier**
33.1637 13.5 cm Str.
33.1637A 13.5 cm Cvd.



Keramo Grip Plier
33.1638 14.5 cm Str.
33.1638A 14.5 cm Cvd.



MAGILL FORCEPS
MAGILL ЩИПЦІ
33.1639
Child - Для дітей
7-1/2", 19cm
33.1640
Adult - Для дорослих
9 3/4", 25cm



YOUNG TONGUE SEIZING FORCEPS
YOUNG ЩИПЦІ ДЛЯ ЗАХОПЛЕННЯ ЯЗИКА
33.1641 With Rubber Jaws, 3 гумовими лещатами
6-1/4", 16cm
33.1642 Replacement Tips, Змінні наконечники 2/set,

Retractors - Mouth Gags



33.1652
Fig. 1
Weitlander
10.5cm
13.5cm



33.1653
Fig. 2
weitlaner
10.5cm
13.5cm



33.1654
Stainless Steel
Double
Ended Cheek
Retractors
Нержавіюча сталь
Двосторонні
розширювачі щік



33.1655
Stainless Steel
Single
Ended Cheek
Retractors
Нержавіюча сталь
Односторонні
розширювачі щік



Weitlander
33.1656 11cm
33.1657 13cm
33.1658 15cm



33.1662
Denhard
12 cm



33.1663
Roser-König
16 cm



33.1664
Roser-König
19 cm



Jennings
33.1659 11cm
33.1660 13cm
33.1661 15cm

Retractors



33.1695
55x11 mm



33.1697
55x11 mm



Ramus retractors
for nasal spine
Ранорозширювачі
нижньощелепової гілки
кістки для носового остюка

33.1696
Kocher
40x11 mm
21 cm

33.1698
Kocher
40x11 mm
21 cm

33.1699
33x20 mm
21 cm



33.1700
35x11 mm
21 cm

Ramus retractors
for nasal spine
Ранорозширювачі
нижньощелепової
гілки кістки для
носого остюка



33.1701
21.5 mm
20x14 mm



33.1702
22 mm
20x22 mm



33.1703
23.5 mm
26x30 mm



Copper Ring Removing



33.1717
Furrer
16 mm
Straight
Прямий



33.1718
Furrer
16 mm
Curved
Зігнутий



33.1719
Bohm
11.5 cm



33.1720
Bohm
14.5 cm

Crown Removers

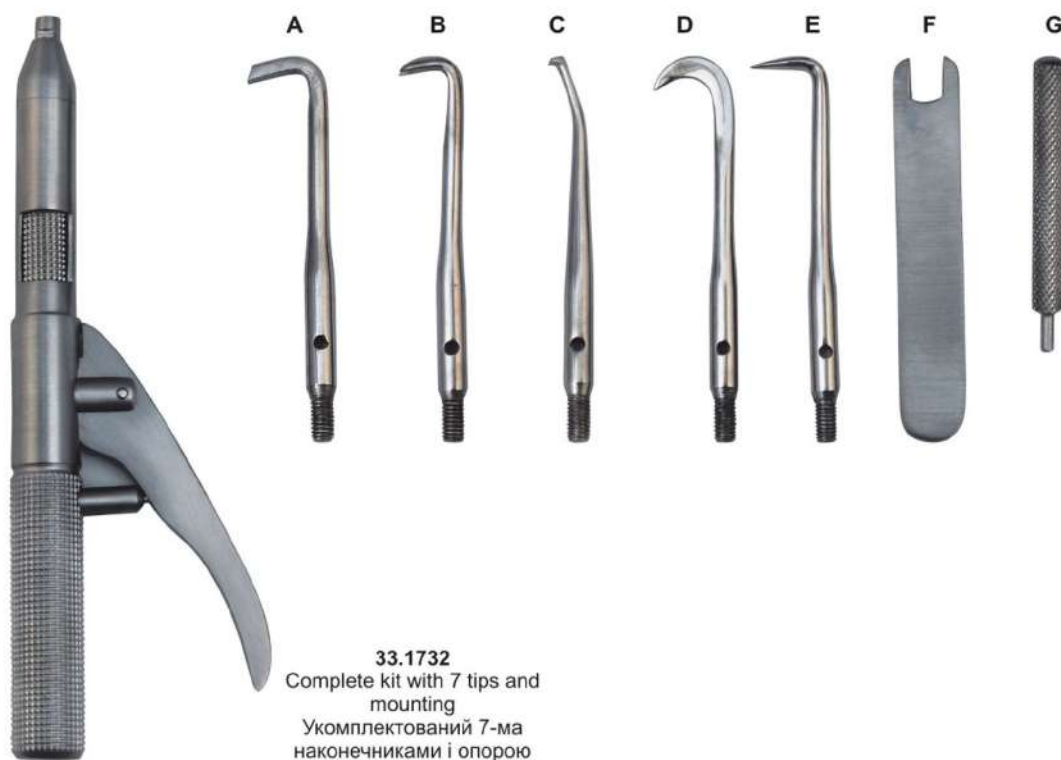
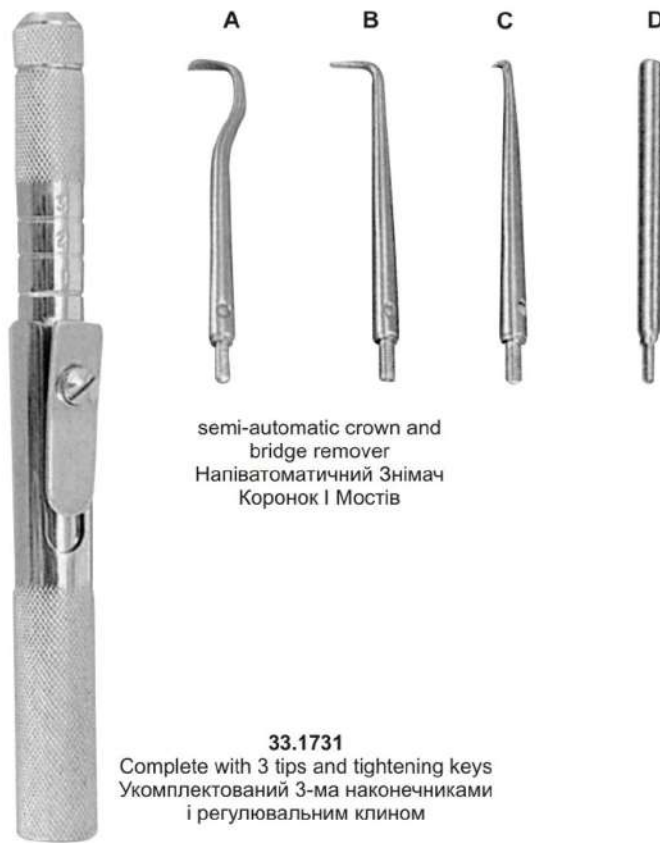

Peridontal Instruments



33.1832
SURGICAL MALLET
ХІРУРГІЧНИЙ МОЛОТОК
6-1/2", 16.5cm



33.1833
Partsch
19 cm
Lead filled



33.1834
Mead 19.5 cm
Non autoclavable
plastic inserts
Не підходить для обробки в
автоклаві Пластмасові втулки



33.1835
Mead Mallet
Mead Хірургічний
молоток



33.1836
Molt



33.1837
Mead 17 cm
Interchangeable
Ferrozell inserts
Взаємозамінні втулки Ferrozell



33.1838
Vickers
19 cm



33.1839
Herbert
19 cm

Pliers For Orthodontics & Prosthetics



34.2049
Bracket Removing Pliers
Кліщі для видалення брекетів



34.2050
Bracket Removing Pliers
Кліщі для видалення брекетів



34.2051
Band removing pliers
Кліщі для видалення ортодонтального назубного кільця



34.2052
Band removers curved, Left and Right
Curved tips provide easy access and grip of band without excess retractor of cheek or lips
Знімачі ортодонтального назубного кільця, вигнуті, вліво і вправо. Вигнуті кінчики забезпечують легкий доступ та захоплення ортодонтального кільця без використання розширювача щік чи губ



34.2053
Left - ????????



34.2054
Right Pliers for Bands
Right Кліщі для ортодонтальних назубних кілець



34.2055
Johnson
Contouring Pliers
Johnson Коронкові кліщі



34.2056
Reynolds
Contouring Pliers
Reynolds Коронкові кліщі



34.2057
For band seating
Для встановлення ортодонтального назубного кільця



34.2058
for incisors with convex beaks
Для різців з випуклими зубцями



34.2059
For bicuspid and molars with concave beaks
Для пре молярів та молярів з увігненими зубцями

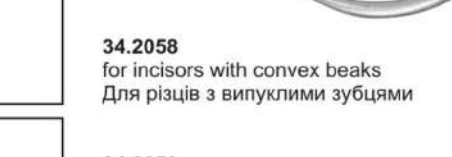

Pliers For Orthodontics & Prosthetics



34.2079
Tweed Loop forming pliers
Tweed Кліщі для формування петель

- 0.36 mm to 0.64 mm (.014" to .025")
- Max. 0.53 mm x 0.64 mm (.021" x .025")



34.2080
Tweed Loop forming pliers
Tweed Кліщі для формування петель

- 0.36 mm to 0.50 mm (.012" to .020")
- Max. 0.46 mm x 0.56 mm (.018" x .022")



34.2081
Nance Loop forming pliers
Nance Кліщі для формування петель

- 0.36 mm to 0.71 mm (.014" to .028")
- Max. 0.56 mm x 0.71 mm (.022" x .028")

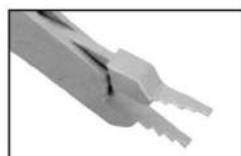

34.2082
De la Rose
Arch forming and contouring pliers
De la Rose, Кліщі коронкові та для формування арок

- 0.36 mm to 0.50 mm (.012" to .020")
- Max. 0.53 mm x 0.64 mm (.021" x .025")



34.2083
Jarabak
Light wire bending pliers
Jarabak, Легкі кліщі для згинання проволочки

- 0.36 mm to 0.50 mm (.018" to .022")
- Max. 0.46 mm x 0.56 mm (.012" x .020")



34.2084
Light wire bending and loop forming pliers
Легкі кліщі для згинання проволочки та формування петель

- 0.36 mm to 0.50 mm (.012" to .020")
- Max. 0.41 mm x 0.56 mm (.016" x .022")



34.2085
Aderer
3-Jaw wire bending pliers
Aderer 3-Щелепові кліщі для згинання проволочки



- 0.36 mm to 0.76 mm (.014" to .030")
- Max. 0.56 mm x 0.71 mm (.022" x .028")



34.2086
Lingual / Palatal arch forming pliers
Язичні/піднебінні кліщі для формування арок



- 0.76 mm to 0.30 mm (.091" to .036")

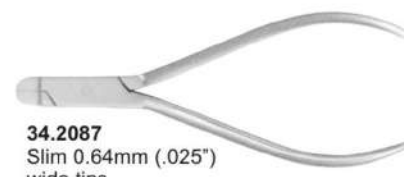

34.2087
Slim 0.64mm (.025") wide tips
arch forming and torquing pliers
Тонкі 0.64 мм (0.25") широкі кінчики
Кліщі для затягування і формування арок

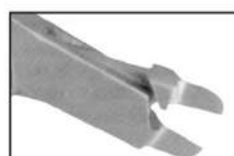

- 0.36 mm to 0.50 mm (.012" to .020")
- Max. 0.41 mm x 0.56 mm (.016" x .022")



34.2088
Angel 1.27mm (.050") wide tips
arch forming and torquing pliers
Нахилені під кутом 1.27 мм (0.25") широкі кінчики
Кліщі для затягування і для формування арок

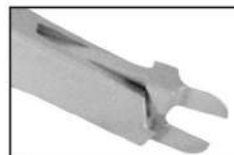

- 0.36 mm to 0.56 mm (.012" to .022")
- Max. 0.53 mm x 0.64 mm (.021" x .025")



34.2089
Tweed / Angel 1.78mm (.070") wide tips
arch forming and torquing pliers
Tweed / нахилені під кутом 1.78 (.070 ") широкі кінчики
Кліщі для затягування і для формування арок



- 0.36 mm to 0.71 mm (.012" to .028")
- Max. 0.56 mm x 0.71 mm (.022" x .028")

Pliers For Orthodontics & Prosthetics



34.2126
Multi-purpose pliers, bird beak,
De la rosa and cutter in one

- 0.30 mm to 0.50 mm (.012" to .020")
- Max. 0.46 mm x 0.56 mm (.018" x .022")



34.2127
Cinch Back / tie back
Distal end bending pliers

- 0.30 mm to 0.50 mm (.012" to .020")
- Max. 0.56 mm x 0.71 mm (.022" x .028")



34.2128
Hammer head
Distal end bending pliers

- 0.30 mm to 0.50 mm (.012" to .020")
- Max. 0.56 mm x 0.71 mm (.022" x .028")



34.2129
Nance
Loop forming pliers

- 0.36 mm to 0.71 mm (.014" to .028")
- Max. 0.56 mm x 0.71 mm (.022" x .028")



34.2130
Detailing step pliers / Bayonet
bending pliers - 1mm

- 0.30 mm to 0.50 mm (.012" to .020")
- Max. 0.56 mm x 0.71 mm (.022" x .028")



34.2131
Stop pliers V-Bebd - 1mm

- 0.30 mm to 0.50 mm (.012" to .020")
- Max. 0.43 mm x 0.56 mm (.017" x .028")



34.2132
Lingual / palatal arch forming plies

- 0.76 mm (.030") / 0.91 mm (.036")



34.2133
Torquing pliers set



34.2134
Tweed / angel
Rectangular arch forming and
torquing pliers

- 0.30 mm to 0.71 mm (.012" to .028")
- Max. 0.56 mm x 0.71 mm (.022" x .028")



34.2135
Surgical ball hook crimping pliers,
angled



34.2136
Surgical ball hook crimping
pliers, straight

Pliers For Orthodontics & Prosthetics

	<p>34.2137 Adams Wire bending pliers</p> <ul style="list-style-type: none"> ● 0.30 mm to 0.81 mm (.014" to .032") ■ Max. 0.56 mm x 0.71 mm (.022" x .028")
	<p>34.2138 Adams Wire bending pliers</p> <ul style="list-style-type: none"> ● 0.30 mm to 0.81 mm (.014" to .032") ■ Max. 0.56 mm x 0.71 mm (.022" x .028")
	<p>34.2139 Universal small Wire bending and cutting pliers</p> <ul style="list-style-type: none"> ● Bends: 0.9 mm (.036") ● Cuts: 0.7 mm (.028")
	<p>34.2140 Universal Dolphin style Wire bending and cutting pliers</p> <ul style="list-style-type: none"> ● Bends: 0.9 mm (.036") ● Cuts: 0.7 mm (.028")
	<p>34.2141 Universal Taper style Wire bending and cutting pliers</p> <ul style="list-style-type: none"> ● Bends: 0.9 mm (.036") ● Cuts: 0.7 mm (.028")
	<p>34.2142 Waldsachs Wire bending and cutting pliers</p> <ul style="list-style-type: none"> ● Bends: 0.9 mm (.036") ● Cuts: 0.7 mm (.028")

	<p>34.2143 Hard wire cutters T.C.</p> <ul style="list-style-type: none"> ● 0.70 mm to 1.00 mm (.028" to .040")
	<p>34.2144 Hard wire cutters T.C.</p> <ul style="list-style-type: none"> ● 0.70 mm to 1.00 mm (.028" to .040")
	<p>34.2145 Hard wire cutters T.C.</p> <ul style="list-style-type: none"> ● 0.60 mm to 0.80 mm (.024" to .032")
	<p>34.2146 Hard wire cutters T.C.</p> <ul style="list-style-type: none"> ● 0.60 mm to 0.80 mm (.024" to .032")
	<p>34.2147 Hard wire cutters</p> <ul style="list-style-type: none"> ● 0.87 mm to 1.1 mm (.028" to .045")
	<p>34.2148 Hard wire cutters</p> <ul style="list-style-type: none"> ● 0.87 mm to 1.1 mm (.028" to .045")

Pliers For Orthodontics & Prosthetics



34.2191
Aderer, small
Wire bending and loop forming pliers

- 0.36 mm to 0.50 mm (.014" to .020")
- Max. 0.53 mm x 0.64 mm (.021" x .025")



34.2192
Aderer, medium
Wire bending and loop forming pliers

- 0.36 mm to 0.71 mm (.014" to .028")
- Max. 0.56 mm x 0.71 mm (.022" x .028")



34.2193
Schwarz, small
Wire bending and loop forming pliers

- Max. 0.50 mm (.020")



34.2194
Schwarz, medium
Wire bending and loop forming pliers

- Max. 0.70 mm (.028")

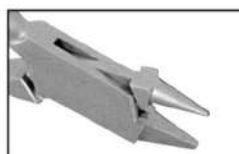

34.2195
Angle
Wire bending and loop forming pliers

- 0.36 mm to 0.71 mm (.014" to .028")
- Max. 0.56 mm x 0.71 mm (.022" x .028")



34.2196
Angle
Wire bending and loop forming pliers

- 0.36 mm to 0.71 mm (.014" to .028")
- Max. 0.56 mm x 0.71 mm (.022" x .028")

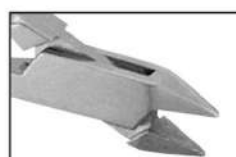

34.2197
Adams, small
Wire bending and loop forming pliers

- 0.36 mm to 0.71 mm (.014" to .028")
- Max. 0.56 mm x 0.71 mm (.022" x .028")

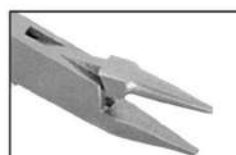

34.2198
Adams, small
Wire bending and loop forming pliers

- 0.36 mm to 0.71 mm (.014" to .028")
- Max. 0.56 mm x 0.71 mm (.022" x .028")



34.2199
Wire bending and loop forming pliers

- 0.36 mm to 0.71 mm (.014" to .028")
- Max. 0.56 mm x 0.71 mm (.022" x .028")



Pliers For Orthodontics & Prosthetics

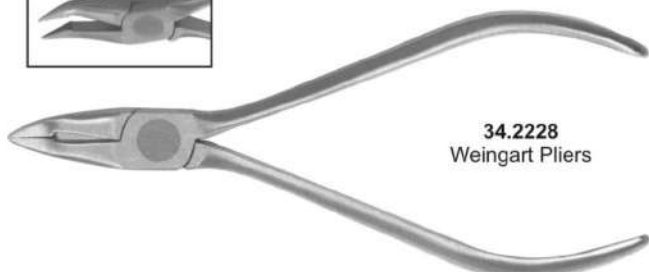

34.2228
Weingart Pliers

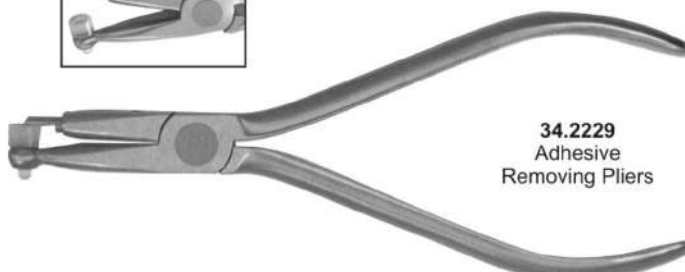

34.2229
Adhesive
Removing Pliers

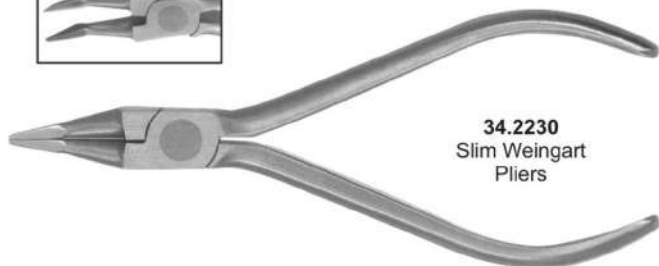

34.2230
Slim Weingart
Pliers

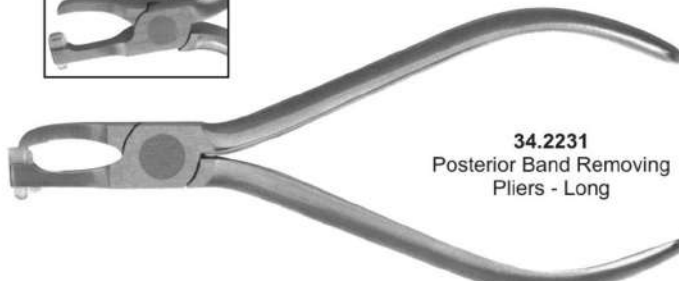
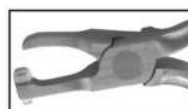

34.2231
Posterior Band Removing
Pliers - Long



34.2232
How Pliers
Straight

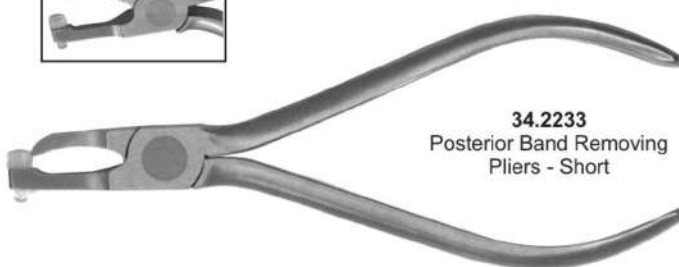

34.2233
Posterior Band Removing
Pliers - Short

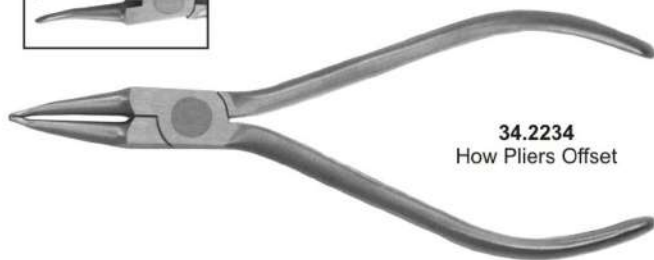

34.2234
How Pliers Offset

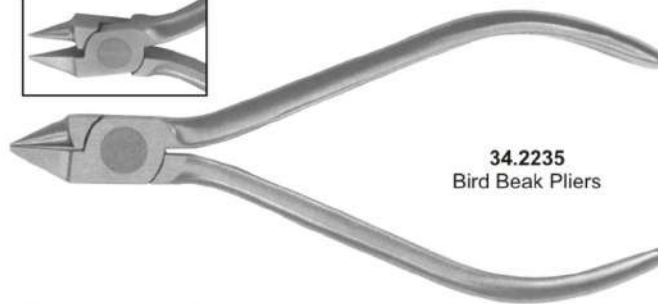

34.2235
Bird Beak Pliers

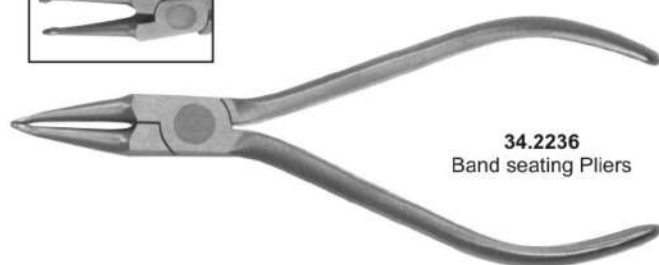

34.2236
Band seating Pliers



Replacement tip and
hex key included.

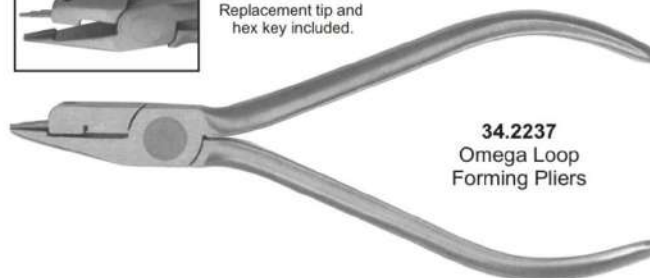

34.2237
Omega Loop
Forming Pliers

Pliers For Orthodontics & Prosthetics

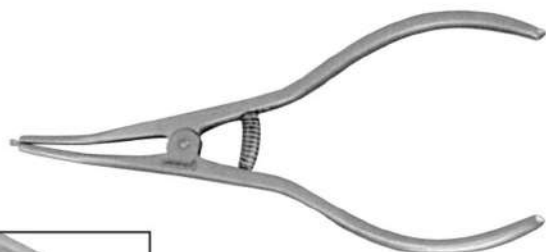

34.2246
Elastomeric separator
placing pliers
160 mm



34.2247
Elastomeric separator
placing pliers
165 mm



34.2248
Elastomeric separator
placing pliers
155 mm

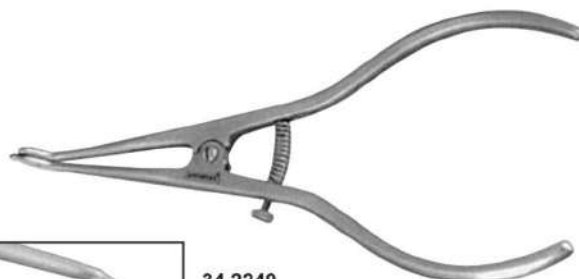

34.2249
Elastomeric separator
placing pliers
165 mm

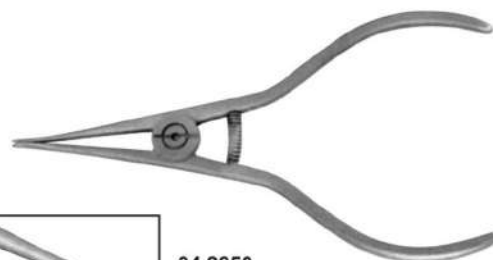

34.2250
Coon
Ligature Tying Forceps

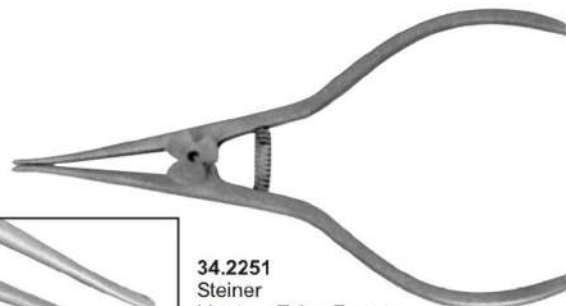

34.2251
Steiner
Ligature Tying Forceps



34.2252
Elastomeric ligature removing tweezers
for easy removal of elastomeric ligatures

Implantology

IMPLANT

SINUS LIFT INSTRUMENTS



Implantology

PERIODONTAL SURGERY

SURGICAL CURETTES



35.2359 PR1/2



35.2360 KRA1



35.2361 KRA2



35.2362 KRA3



KIRKLAND

35.2363 KN3/4



35.2364 KIR4/5



35.2365 KIR8/9



KRAMER NEVINS CURETTES

35.2366 KIR12/14



35.2367 Kn152



SUGARMAN

35.2368 KN5/6



35.2369 SS5/6



35.2370 SS9/10



35.2661
Fig. 34 N



35.2662
Fig. 34 M



35.2663
Fig. 35 N



35.2664
Fig. 35 M



35.2665
Fig. 35



35.2666
Fig. 35 A

Implantology

RETRACTORS РЕТРАКТОРИ



35.2691
Bishop Retractor
Bishop ретрактор



35.2692
Cawood Minnesota
Retractor
Cawood Minnesota
ретрактор



35.2693
Sinus Retractor
Синус- ретрактор



35.2694
Plastic Cheek Retractor
Double Handle
Autoclavable



35.2695
Austin Retractor
Austin Ретрактор

Impression Trays

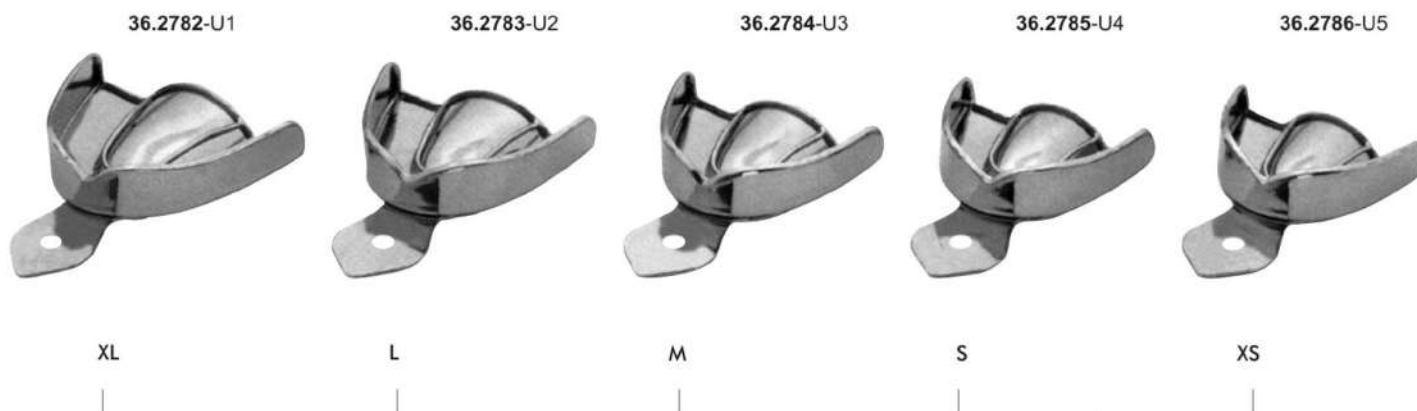

Upper - Верхня		A (left-right) (ліво-право)	B (top-bottom) (верх-низ)
36.2782.U1	XL	83 mm	62 mm
36.2783.U2	L	75 mm	60 mm
36.2784.U3	M	73 mm	53 mm
36.2785.U4	S	69 mm	54 mm
36.2786.U5	XS	68 mm	52 mm

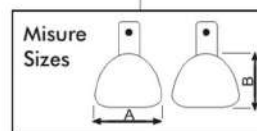

Lower - Нижня		A (left-right) (ліво-право)	B (top-bottom) (верх-низ)
36.2787.L1	XL	82 mm	63 mm
36.2788.L2	L	81 mm	61 mm
36.2789.L3	M	78 mm	57 mm
36.2790.L4	S	74 mm	60 mm
36.2791.L5	XS	71 mm	53 mm

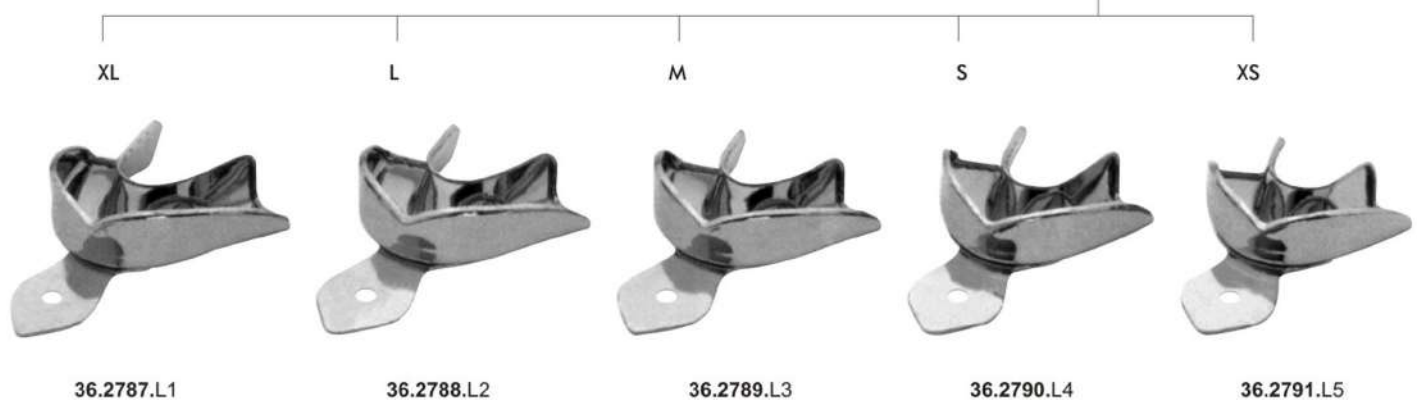
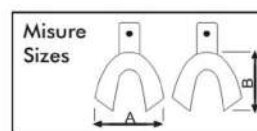

36.2787.L1

36.2788.L2

36.2789.L3

36.2790.L4

36.2791.L5

Impression Trays

Perforated Without Rim Lock

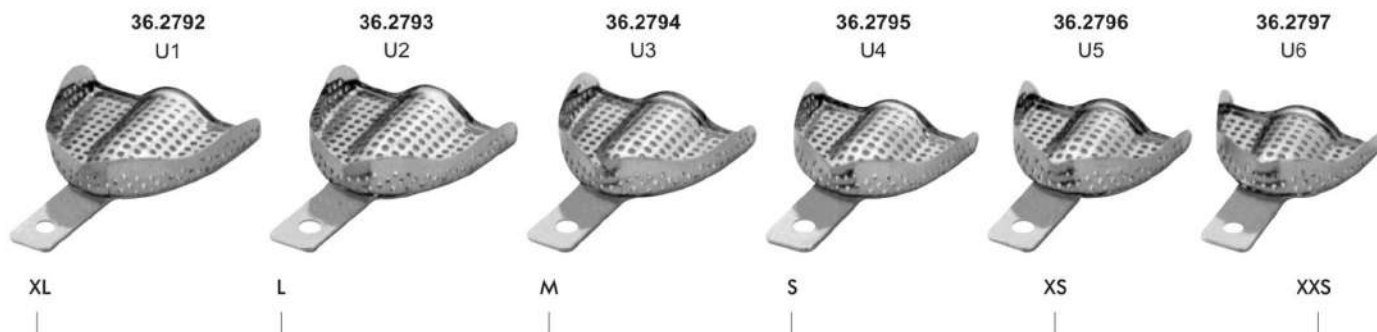

Upper - Верхня		A (left-right) (ліво-право)	B (top-bottom) (верх-низ)
36.2792.U1	XL	81 mm	63 mm
36.2793.U2	L	73 mm	58 mm
36.2794.U3	M	71 mm	52 mm
36.2795.U4	S	67 mm	53 mm
36.2796.U5	XS	65 mm	51 mm
36.2797.U6	XXS	61 mm	50 mm

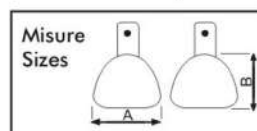

Lower - Нижня		A (left-right) (ліво-право)	B (top-bottom) (верх-низ)
36.2798-L1	XL	78 mm	63 mm
36.2799-L2	L	74 mm	62 mm
36.2800-L3	M	72 mm	59 mm
36.2801-L4	S	70 mm	57 mm
36.2802-L5	XS	69 mm	55 mm
36.2803-L6	XXS	59 mm	50 mm

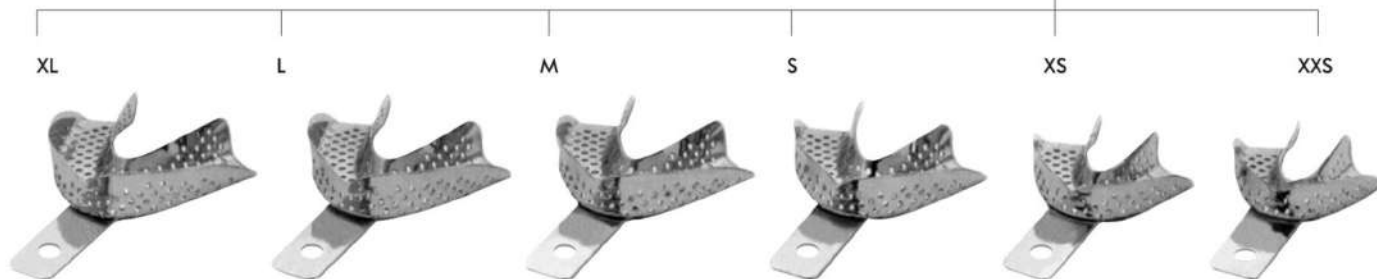
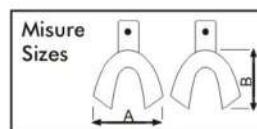

36.2798
L1

36.2799
L2

36.2800
L3

36.2801
L4

36.2802
L5

36.2803
L6



36.2804.L2D

36.2805.L4D

36.2806.L6D

36.2807.L2S

36.2808.L4S

36.2809.L6S

Impression Trays

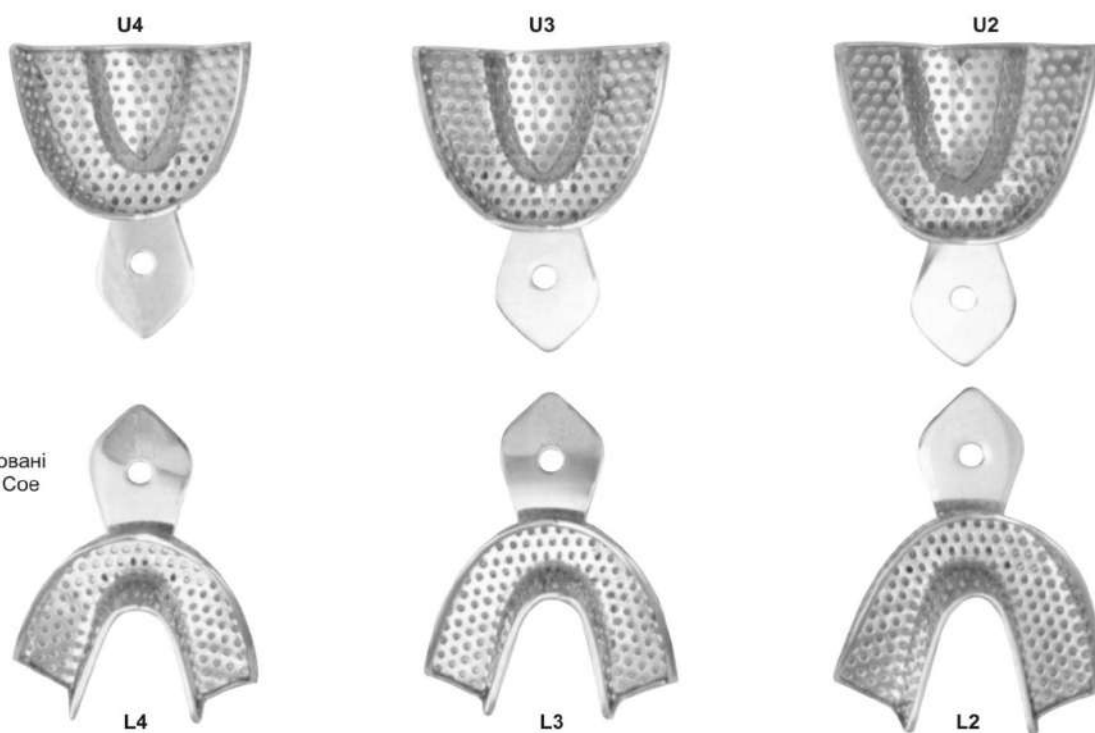

36.2881

Impression Trays

Set of 6 Pieces

Perforated Stainless

steel CoeType

Ложки для зліпків набір

із 6 інструментів Перфоровані

із нержавіючої сталі типу Coe

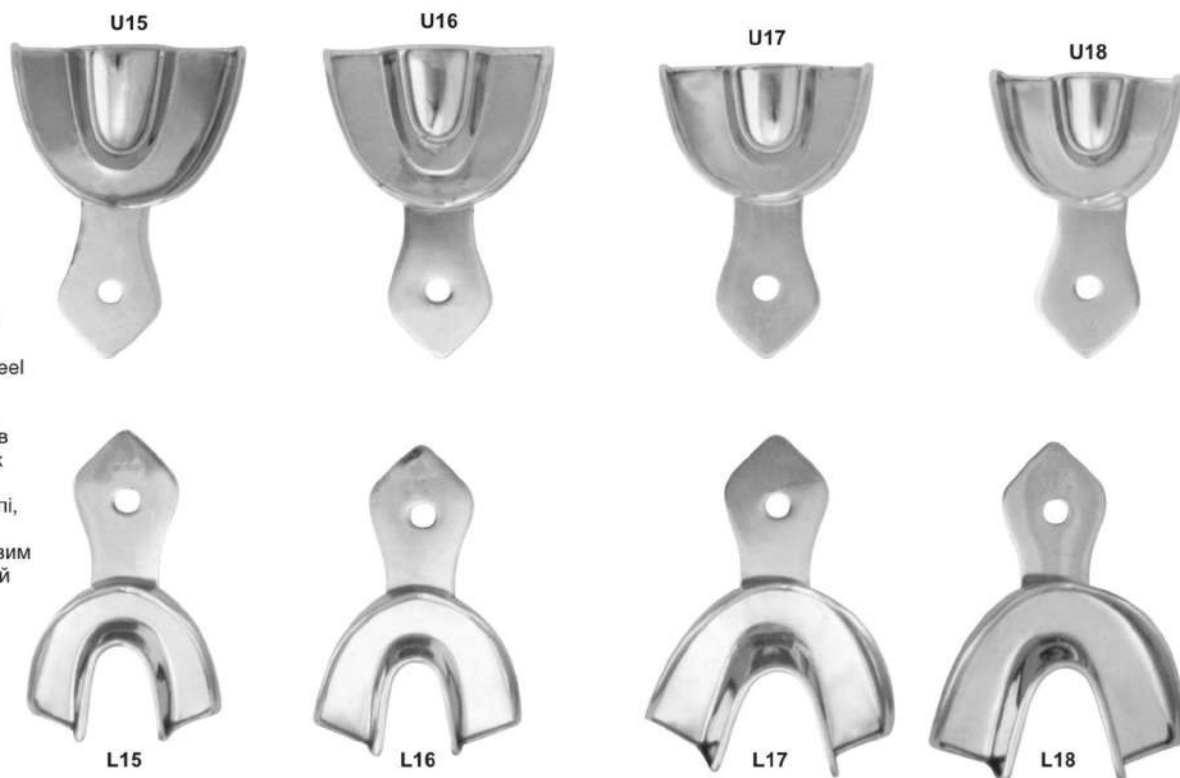

36.2882

Impression Trays

Set of 8 Pieces

Plain Stainless steel

Rim Lock Type

for Children

Ложки для зліпків

набір з 8 гладких

інструментів із

нержавіючої сталі,

тип із обідком із

замковим бортовим

кільцем для дітей

Sterilizing Forceps



DAVIS
36.3038 16 cm, 6 ¼"
36.3039 20 cm, 8"
36.3040 24 cm, 9 ½"

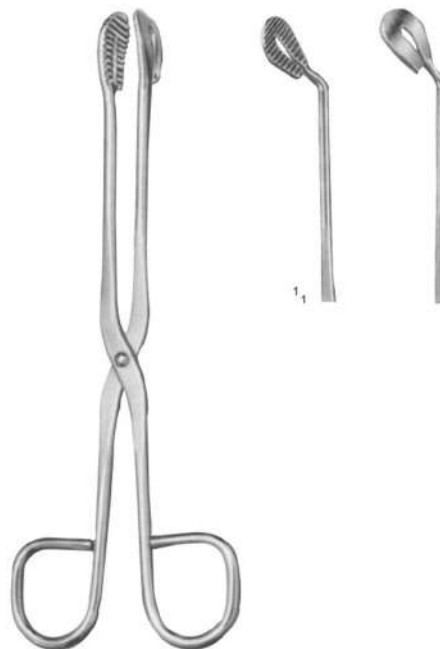

UTILITY
36.3041 20 cm, 8"
36.3042 28 cm, 11"



36.3043 20 cm, 8"
36.3044 25 cm, 10"
36.3045 30 cm, 11 ¾"



ROGGE
36.3046
 27 cm, 11"



CHEATTEL
 Box Joint
36.3047
 27 cm, 11"



CHEATTEL
 Screw Joint
36.3048
 27 cm, 11"

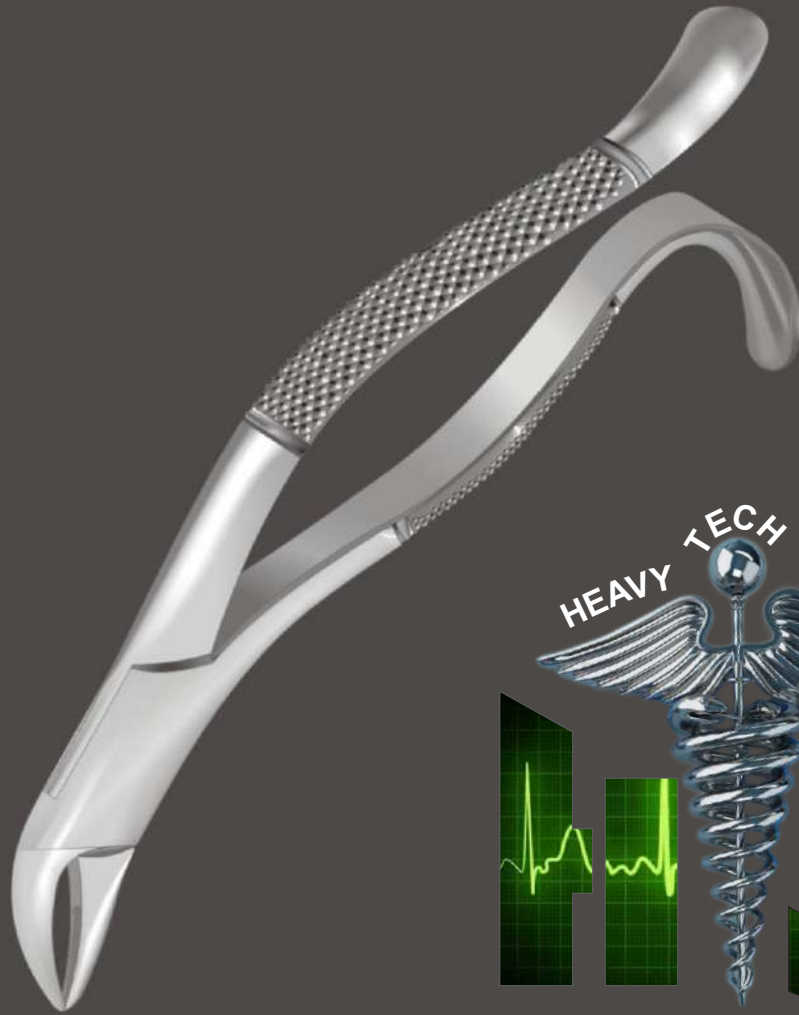

Opposite Allama Iqbal Memorial Hospital,
1st Street, Muhammad Pura,
Sialkot, PAKISTAN.

 +92 320 5831682.

 info@htsurgico.com

www.htsurgico.com

Certifications



Members

